

# Certifier™ Pro Flow Analyzer Test System Model 4090



User Manual

P/N 6016808, Revision B  
May 2023



# Start Seeing the Benefits of Registering Today!

Thank you for your TSI® instrument purchase. Occasionally, TSI® releases information on software updates, product enhancements and new products. By registering your instrument, TSI® will be able to send this important information to you.

<http://register.tsi.com>

As part of the registration process, you will be asked for your comments on TSI products and services. TSI's customer feedback program gives customers like you a way to tell us how we are doing.

# Warranty

## Copyright©

TSI Incorporated / 2023 / All rights reserved.

## Address

TSI Incorporated / 500 Cardigan Road / Shoreview, MN 55126 USA



### WARNING

TSI® Certifier™ Flow Analyzers employ a heated platinum sensor. They **SHOULD NOT** be used with flammable or explosive gases or mixtures.

TSI® Certifier™ Flow Analyzers are not designed for use with anesthesia gas other than nitrous oxide. Only an anesthesia gas measurement accessory is designed for use with these gases.



### CAUTION

TSI® Certifier™ Flow Analyzers are not medical devices under FDA 510k and in no situation should they be utilized for human respiration measurements.



### ATTENTION

As indicated by the WEEE Symbol on the case of the instrument, this product should not be discarded as unsorted waste but must be sent to separate collection facilities for recovery and recycling.

## Limitation of Warranty and Liability (effective February 2015)

(For country-specific terms and conditions outside of the USA, please visit [www.tsi.com](http://www.tsi.com).)

Seller warrants the goods, excluding software, sold hereunder, under normal use and service as described in the operator's manual, to be free from defects in workmanship and material for **2 years** (24 months), or if less, the length of time specified in the operator's manual, from the date of shipment to the customer. This warranty period is inclusive of any statutory warranty. This limited warranty is subject to the following exclusions and exceptions:

- a. Hot-wire or hot-film sensors used with research anemometers, and certain other components when indicated in specifications, are warranted for 90 days from the date of shipment;
- b. Pumps are warranted for hours of operation as set forth in product or operator's manuals;
- c. Parts repaired or replaced as a result of repair services are warranted to be free from defects in workmanship and material, under normal use, for 90 days from the date of shipment;
- d. Seller does not provide any warranty on finished goods manufactured by others or on any fuses, batteries or other consumable materials. Only the original manufacturer's warranty applies;
- e. This warranty does not cover calibration requirements, and seller warrants only that the instrument or product is properly calibrated at the time of its manufacture. Instruments returned for calibration are not covered by this warranty;
- f. This warranty is **VOID** if the instrument is opened by anyone other than a factory authorized service center with the one exception where requirements set forth in the manual allow an operator to replace consumables or perform recommended cleaning;
- g. This warranty is **VOID** if the product has been misused, neglected, subjected to accidental or intentional damage, or is not properly installed, maintained, or cleaned according to the requirements of the manual. Unless specifically authorized in a separate writing by Seller, Seller makes no warranty with respect to, and shall have no liability in connection with, goods which are incorporated into other products or equipment, or which are modified by any person other than Seller.

The foregoing is **IN LIEU OF** all other warranties and is subject to the **LIMITATIONS** stated herein. **NO OTHER EXPRESS OR IMPLIED WARRANTY OF FITNESS FOR PARTICULAR PURPOSE OR MERCHANTABILITY IS MADE. WITH RESPECT TO SELLER'S BREACH OF THE IMPLIED WARRANTY AGAINST INFRINGEMENT, SAID WARRANTY IS LIMITED TO CLAIMS OF DIRECT INFRINGEMENT AND EXCLUDES CLAIMS OF CONTRIBUTORY OR INDUCED INFRINGEMENTS. BUYER'S EXCLUSIVE REMEDY SHALL BE THE RETURN OF THE PURCHASE PRICE DISCOUNTED FOR REASONABLE WEAR AND TEAR OR AT SELLER'S OPTION REPLACEMENT OF THE GOODS WITH NON-INFRINGEMENT GOODS.**

TO THE EXTENT PERMITTED BY LAW, THE EXCLUSIVE REMEDY OF THE USER OR BUYER, AND THE LIMIT OF SELLER'S LIABILITY FOR ANY AND ALL LOSSES, INJURIES, OR DAMAGES CONCERNING THE GOODS (INCLUDING CLAIMS BASED ON CONTRACT, NEGLIGENCE, TORT, STRICT LIABILITY OR OTHERWISE) SHALL BE THE RETURN OF GOODS TO SELLER AND THE REFUND OF THE PURCHASE PRICE, OR, AT THE OPTION OF SELLER, THE REPAIR OR REPLACEMENT OF THE GOODS. IN THE CASE OF SOFTWARE, SELLER WILL REPAIR OR REPLACE DEFECTIVE SOFTWARE OR IF UNABLE TO DO SO, WILL REFUND THE PURCHASE PRICE OF THE SOFTWARE. IN NO EVENT SHALL SELLER BE LIABLE FOR LOST PROFITS, BUSINESS INTERRUPTION, OR ANY SPECIAL, INDIRECT, CONSEQUENTIAL OR INCIDENTAL DAMAGES. SELLER SHALL NOT BE RESPONSIBLE FOR INSTALLATION, DISMANTLING OR REINSTALLATION COSTS OR CHARGES. No Action, regardless of form, may be brought against Seller more than 12 months after a cause of action has accrued. The goods returned under warranty to Seller's factory shall be at Buyer's risk of loss, and will be returned, if at all, at Seller's risk of loss.

Buyer and all users are deemed to have accepted this LIMITATION OF WARRANTY AND LIABILITY, which contains the complete and exclusive limited warranty of Seller. This LIMITATION OF WARRANTY AND LIABILITY may not be amended, modified or its terms waived, except by writing signed by an Officer of Seller.

**Service Policy**

Knowing that inoperative or defective instruments are as detrimental to TSI attention to any problems. If any malfunction is discovered, please contact your nearest sales office or representative, or call TSI's Customer Service department at (800) 680-1220 (USA) or (001 651) 490-2860 (International) or visit [www.tsi.com](http://www.tsi.com).

**Trademarks**

TSI and TSI logo are registered trademarks of TSI Incorporated in the United States and may be protected under other country's trademark registrations. Certifier is a trademark of TSI Incorporated. REDEL is a registered trademark of Interlemon Holding S.A. Luer-Lok is a registered trademark of Becton Dickinson. Phillips is a trademark of Phillips Screw Company.

# Contents

<b>Warranty</b> .....	<b>iii</b>
<b>Contents</b> .....	<b>v</b>
<b>CHAPTER 1 Introduction and Parts Identification</b> .....	<b>1-1</b>
Introduction .....	1-1
High Flow Channel .....	1-1
Low Flow Channel .....	1-1
Pressure Measurements.....	1-1
Oxygen Concentration .....	1-1
List of Standard Components .....	1-2
Certifier™ Pro Flow Analyzer Test System (Model 4090).....	1-2
List of Optional Accessories.....	1-3
Flow Resistor Kit (PN 130395) .....	1-4
Certifier™ Connector Kit (PN 130391)*.....	1-4
Hanging Clip (PN 130395).....	1-4
<b>CHAPTER 2 Flow Analyzer Overview</b> .....	<b>2-1</b>
Instrument Overview .....	2-1
Model 4090 Instrument, Front.....	2-1
Model 4090 Instrument, Back.....	2-1
Model 4090 Instrument, Bottom.....	2-2
Operation Overview .....	2-3
Flow Channels .....	2-3
End Caps .....	2-3
Lithium Ion Batteries .....	2-3
Supplying Power.....	2-3
Power Button LED States .....	2-3
Touchscreen Display .....	2-4
User Configurations .....	2-4
Data Acquisition and Export .....	2-4
Portable/Rack Mode .....	2-5
Measurements and Units .....	2-5
Available Measurement Parameters .....	2-5
Available Units of Measurement.....	2-6
Measurement Parameter Definitions .....	2-7
<b>CHAPTER 3 Flow Analyzer Setup</b> .....	<b>3-1</b>
Getting Started.....	3-1
Power On/Off .....	3-1
Initialization and Warm-Up.....	3-1
Instrument Setup.....	3-1
Connect Inlet Filters.....	3-1
Connect the Low Pressure Measurement .....	3-1
Breath Triggers .....	3-2
Connect the Certifier™ Pro to a Ventilator .....	3-2
Pre-Test Checks .....	3-4
Flow Measurement .....	3-4
Flow Direction Sensor.....	3-4
Low-Pressure and High-Pressure Transducer Zeroing.....	3-4
Oxygen Sensor Calibration.....	3-4
Flow Compare.....	3-4

<b>CHAPTER 4 Touchscreen Operation .....</b>	<b>4-1</b>
Display Interface Overview .....	4-1
Parameter Screen .....	4-1
Warnings and Errors .....	4-3
Graph Screen .....	4-4
Channel Cards .....	4-5
Menu Screen .....	4-6
Configuring the Analyzer .....	4-6
Measurements and Units .....	4-6
Gas Type and Gas Condition .....	4-8
Breath Triggers .....	4-9
Averaging .....	4-11
Using Configurations .....	4-12
Managing Configurations .....	4-12
Loading Configurations .....	4-13
Saving Configurations .....	4-14
Exporting Configurations .....	4-15
Importing Configurations .....	4-16
Editing the Graph Screen .....	4-16
Plotted Measurements .....	4-17
Y-Axis Scaling .....	4-18
X-Axis Scaling .....	4-18
Trigger Indicators .....	4-19
Real-Time Measurements .....	4-19
Zeroing and Calibration .....	4-20
Zero Pressure Sensors .....	4-20
Calibrate Oxygen Sensor .....	4-21
Set Installation Date .....	4-22
Data Logging and Export .....	4-23
Data Acquisition .....	4-23
Managing Data .....	4-26
Exporting Data .....	4-28
Viewing Exported Data .....	4-29
Device Settings .....	4-30
General Settings .....	4-30
Date/Time .....	4-30
Display/Power Management .....	4-31
Triggers and Averaging .....	4-31
Oxygen Sensor .....	4-31
Device Information .....	4-32
Update Firmware .....	4-32
<b>CHAPTER 5 Troubleshooting .....</b>	<b>5-1</b>
<b>CHAPTER 6 Maintenance .....</b>	<b>6-1</b>
Recharging the Battery .....	6-1
Replacing the Battery .....	6-1
Battery Calibration .....	6-2
Replacing the Oxygen Sensor .....	6-3
Cleaning the Flow Analyzer .....	6-3
Factory Calibration (recommended annually) .....	6-4
Return Procedure .....	6-4

<b>CHAPTER 7 Specifications</b> .....	<b>7-1</b>
Physical.....	7-1
Environmental .....	7-1
Power .....	7-1
Compliance .....	7-1
Measurements .....	7-2
Certifier™ Pro Flow Analyzer Pressure Drop .....	7-4
Low Flow Channel .....	7-4
High Flow Channel .....	7-4
<b>APPENDIX A Data Export Formats</b> .....	<b>A-1</b>
Snapshot Data File from the Parameter Screen.....	A-1
Snapshot Data File from the Graph Screen.....	A-1
Continuous Log file (Initiated from the Parameter Screen or Graph Screen).....	A-2
Waveform Log file (Initiated from the Parameter Screen or Graph Screen) .....	A-3

*(This page intentionally left blank)*



# Introduction and Parts Identification

---

## Introduction

The Certifier™ Pro Flow Analyzer is a multi-functional pneumatic test system designed for biomedical professionals to test respiratory medical equipment such as mechanical ventilators, anesthesia machines, PAP devices, oxygen concentrators, air-oxygen blenders, and insufflators. The Certifier™ Pro Flow Analyzer is used in manufacturing, hospital, field service, research, laboratory, and home care settings.

The Certifier™ Pro Flow Analyzer test system measures gas flows, volumes, pressures, oxygen concentration, breath timing, and other breathing parameters. The instrument contains both a high flow and low flow channel, an integrated oxygen sensor, and a rechargeable lithium-ion battery.

### High Flow Channel

The high flow channel measures bi-directional flow rate for air, oxygen (O<sub>2</sub>), nitrogen (N<sub>2</sub>) and carbon dioxide (CO<sub>2</sub>) over a range of 0 to 300 standard liters per minute (0 to 40 standard L/min for CO<sub>2</sub>). By default, the high flow channel controls triggering for the Certifier™ Pro instrument unless the channel is powered down.

### Low Flow Channel

The low flow channel measures uni-directional flow rate for air, O<sub>2</sub>, N<sub>2</sub>, CO<sub>2</sub> and nitrous oxide (N<sub>2</sub>O) over a range of 0.01 to 20 standard L/min with greater accuracy at low flow rates.

### Pressure Measurements

An integrated gauge transducer (150 psi/10 Bar), barometric pressure transducer (375 to 1200 mmHg), and low differential pressure transducer (150 cm H<sub>2</sub>O) provide multiple pressure measurements from the front panel.

### Oxygen Concentration

An integrated oxygen sensor enables the measurement of oxygen concentration and air-oxygen gas flows from the high flow channel. The oxygen sensor is field replaceable by the user.



#### CAUTION

- To avoid inaccurate test readings, **DO NOT** obstruct the tubing or inlet or outlet ports, and always use clean, dry gas.
- To avoid damage to the Certifier™ Pro test system components, always use an inlet filter upstream of the instrument, and always cap ports when not in use.
- If liquid has penetrated any of its components, **DO NOT** use, and return to the factory for calibration.
- The Certifier™ Pro test system **IS NOT** a medical device under the Medical Device Directive or FDA 510(k) and in no situation should be used for human measurements.

# List of Standard Components







Carefully unpack the test system components from the shipping container. Check the individual parts against the packing list and notify TSI® immediately if any parts are missing or damaged.

## Certifier™ Pro Flow Analyzer Test System (Model 4090)

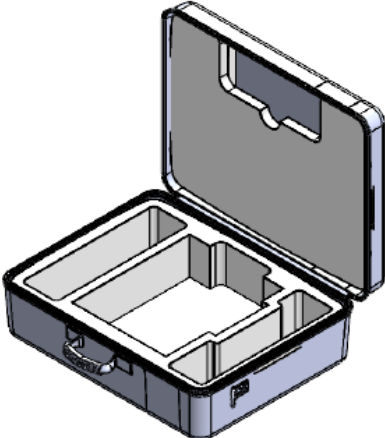

Item Number	Description	Replacement Part Number	Qty.
1	Certifier™ Pro Flow Analyzer	4090	1
2	High Flow Inlet Filter, 22 mm x 22 mm M/F, HEPA	1602341	1
3	Low Flow Inlet Filter, 1/4 inch, HEPA, plus tubing	1602317	1
4	Adapter, high pressure port	1611221	1
5	Adapter, 22 mm x 6 mm (to connect to Low Flow Filter to high flow channel using 130373 F/F adapter)	1102091	2
6	Adapter, 15 mm ID x 22 mm OD	1102093	1
7	Adapter, 22 mm F to 22 mm F, Straight	130373	1
8	Adapter, 15 mm M to 22 mm F, Pediatric cuff	130374	1
9	Airway pressure fitting with screen	1611330	1
10	Pressure tubing, silicone, 1/8-inch ID x 1/4-inch OD x 48 in.	3002053	1
11	Power supply 100/240 VAC to +12 VDC 2.1 mm plug, includes plug set with NA, UK, EU, CN, SAA connectors	130400	1
12	Oxygen sensor cell (installed)	130377	1
13	Battery, 4 cell Lithium-Ion 7.2 V 6.4 AHr (installed)	130385	1
14	Hanging Clip (to hang the instrument from a ventilator rail)	130375	1

## List of Optional Accessories

Description	Part Number	Image
Carrying Case, Fitted for the Certifier™ Pro Flow Analyzer 19 x 14.75 x 6.5 inches (48 x 37.5 x 16.5 cm)	130378	
Test Lung, Adult, 1.0L, includes elbow connector 15 mm ID x 22 mm OD	130396	
Test Lung, Pediatric, 0.5L, includes one elbow connector and two straight connectors with Luer-Lok® ports and locks, connectors include a variable leak adjustment to demonstrate patient-trigger function or to simulate an airway leak.	130397	
Locking Computer Cable, USBC to USBA, screw lock (2 m), screwdriver	130382	
Stylus, Capacitive touch	130370	
Oxygen Sensor Cell Replacement (for the Certifier™ Pro Flow Analyzer)	130377	

## Flow Resistor Kit (PN 130395)

Flow resistors are calibrated airway adapters used to simulate nominal levels of resistance. Resistors can be used to demonstrate or test changes in airway resistance. The Flow Resistor Kit adapters can be cleaned and sterilized.

The kit includes three resistors:  
Rp5, Rp20 and Rp50.



## Certifier™ Connector Kit (PN 130391)\*



Item	Description	Part Number	Quantity
5	Adapter, 22 mm x 6 mm (to connect Low Flow Filter to High Flow Channel)	1102091	2
6	Adapter, 15 mm ID x 22 mm OD	1102093	1
7	Adapter, 22 mm F to 22 mm F, Straight	130373	1
8	Adapter, 15 mm M to 22 mm F, Pediatric cuff	130374	1
9	Airway pressure fitting with screen	1611330	1

\*All of these connectors are included standard in the Certifier™ Pro 4090 Kit.

## Hanging Clip (PN 130395)

Used to hang the Certifier Pro instrument by its handle from a ventilator rail (the Hanging Clip is included as part of the Certifier™ Pro 4090 Kit).



# Flow Analyzer Overview

## Instrument Overview

### Model 4090 Instrument, Front



1.	Low Flow Channel Inlet	4.	Low Differential Pressure, Positive Port (+)
2.	High Flow Channel Inlet	5.	Low Differential Pressure, Negative Port (-)
3.	High Pressure Port (Max: 150 psi / 10 bar)	6.	Touchscreen Display

### Model 4090 Instrument, Back



1.	Low Flow Channel Outlet	7.	USB-C Communications Output
2.	High Flow Channel Outlet	8.	Screw hole for USB-C cable lock
3.	Power Button (On/Off)	9.	USB-A Connectors (2)
4.	RS-232 Output	10.	Portable / Rack Switch
5.	TTL Trigger Input	11.	Cable Retainer
6.	DC Power Input (2.1mm barrel jack)	12.	Model / Serial Number Sticker

## Model 4090 Instrument, Bottom



1.	Battery/Oxygen Sensor Cover	4.	Rubber Feet
2.	Cover Knob	5.	Fan
3.	Instrument Handle	6.	Cable Retainer

---

# Operation Overview

## Flow Channels

Measurements from both flow channels are available for simultaneous use. You can connect or disconnect your test circuit to or from the Certifier™ Pro Flow Analyzer at any time during normal operation without having to reboot the instrument or change settings. You can turn off the individual flow channels to reduce power consumption and extend battery operation. See [Chapter 4, "Flow Channel Power Toggles"](#) for more information on disabling power for flow channels.

The high flow channel measures flows up to 300 L/min using bi-directional flow sensing. The low flow channel can measure flows under 2.5 L/min with greater accuracy than the high flow channel. The low flow channel uses uni-directional flow sensing and reports all measured flows as positive values. The low flow channel contains the N<sub>2</sub>O gas type which is often used for testing anesthesia work stations.

## End Caps

TSI® flow analyzers measure flow utilizing an exposed thermal flow sensor that is highly sensitive to foreign matter and particles within the gas flow. TSI® supplies end caps for both the high flow and low flow channels and recommends that the flow inlets and outlets be capped when not in use.



### CAUTION

To avoid damage to the Certifier™ Pro Test System components, always cap the ends of the flow inlets/outlets when not in use.

## Lithium Ion Batteries

The Certifier™ Pro Flow Analyzer utilizes a 4-cell lithium ion battery pack which can provide up to six (6) hours of continuous operation from a full charge. The battery pack is calibrated and installed into the instrument at the factory. The battery pack is rechargeable and can be charged internally by providing power via the AC power adapter. The battery pack can be replaced by users in the field.

## Supplying Power

The Certifier Pro Flow Analyzer can be powered by internal Lithium-Ion batteries or an AC power adapter can be used. Refer to [Chapter 7](#) of this manual for the power supply specifications.

If the AC adapter is delivering power to the flow analyzer with the battery installed, the battery symbol on the display will contain a lightning bolt to indicate that the battery is being charged. If the AC adapter is powering the instrument but no battery is installed, a question mark symbol will appear within the battery symbol.

### NOTICE

When running the Certifier Pro Flow Analyzer on battery power without an AC connection, the device will shut down automatically if the battery charge reaches 5% in order to prevent battery damage from occurring.

## Power Button LED States

The power button contains an LED that changes state and color depending on the condition of the Certifier Pro instrument. If the Certifier Pro Flow Analyzer is running with the battery installed while connected to power via the power cable, then the power button will display the following LED states:

- Blinking red: 0–10% battery charge
- Solid red: 10–20% battery charge
- Solid green: >20% battery charge

If the Certifier™ Pro Flow Analyzer is turned off with the battery installed while connected to power via the power cable, the power button will display the following LED states:

- Solid yellow: Battery is charging
- Blinking yellow: Battery is full, no charging needed

If no battery is installed and the Certifier™ Pro Flow Analyzer is connected to power via the power cable, the power button will display a solid green LED when the instrument is powered on. The power button will not display any LED status if the Certifier Flow Analyzer is turned off and no power is connected.

## Touchscreen Display

The Certifier™ Pro Flow Analyzer utilizes a 5-inch color, capacitive touchscreen display. The Certifier graphical user interface (GUI) is designed to be operated using your fingers; however, a capacitive-touch stylus can also be used as an alternative. Press with your fingers lightly on the display for optimal touchscreen operation.

To operate the Certifier Pro test system, touch any on-screen element that you would like to change. Between 1 and 18 measurement parameters can be displayed on screen at one time, and the display will automatically adjust the font and positioning of the text based on the number of measurements selected. The display brightness can be adjusted in the **Settings** option of the Certifier Pro user interface.

## User Configurations

A user configuration is a collection of setting values for the measurements, units, gas type and conditions, triggering, and graph settings that can be saved and recalled at a later time. This allows you to save and load different test setups for specific models of equipment or to ensure test setups conform with organizational standards or personal preference.

Up to 20 different user configurations can be stored in the internal memory of the Certifier Pro Model 4090 Flow Analyzer and can be exported from either USB-A port on the back of the instrument to a USB mass storage device. Exported user configurations can then be imported onto other Certifier Pro Model 4090 or Certifier Plus Model 4089 instruments. Exported configurations can also be sent as email attachments.

## Data Acquisition and Export

The Certifier™ Pro Flow Analyzer is capable of logging measurement data and capturing screenshots. Files are saved to the internal memory of the Certifier™ Flow Analyzer and can be exported through either of its two USB-A ports. Saved measurement data is exported as .csv files and screenshots are exported as .png files.

The Certifier™ Pro Flow Analyzer offers the following data acquisition options:

- **Snapshot** – saves a screenshot image and the data currently displayed, either from the **Parameter** screen or **Graph** screen. Upon executing a snapshot, the Certifier Flow Analyzer will create two files, an image file (.PNG) for the screen capture and a data file (.CSV) with a single data point.
- **Continuous Log** – captures data for the measurements currently selected on screen. The sampling rate at which data is collected can be set from 1 second to 10 minutes. The collection time can be set from 15 seconds to up to 5 days (120 hours) of continuous logging.
- **Waveform Log** – records raw sensor data at high resolution for flow rate, low pressure, high pressure, absolute pressure, temperature, and oxygen concentration (if connected). The sampling rate for waveform logging is fixed at 1 ms (1000 Hz), and you can specify the collection time from 15 to 60 seconds.



## Portable/Rack Mode

In Portable mode, the instrument will run on battery power if no power is supplied. In Rack mode, the instrument will turn on when power is supplied and turn off when power is removed.

### NOTICE

In Rack mode, the Certifier™ Flow Analyzer **will not** allow you to cancel the auto shutdown process if no power is supplied.

## Measurements and Units

### Available Measurement Parameters

Some of the parameters listed are only available from the high flow channel.

Symbol	Description	Symbol	Description
$\dot{V}$	Flow rate	$P_{\text{PLAT}}$	Plateau pressure – pressure at the end of the inspiratory phase during no flow (4081 only)
$\dot{V}_{\text{PEAK}}$	Peak flow rate – Peak inhaled flow rate	$P_{\text{HIGH}}$	High pressure measurement (4081 only)
$\dot{V}_{\text{MIN}}$	Minimum flow rate – the negative of the peak exhaled flow rate in a bi-directional test circuit.	$P_{\text{ABS}}$	Absolute pressure in flow tube. Equals barometric pressure if flow tube is open to atmosphere.
$\dot{V}_{\Delta}$	Flow rate delta – the numerical difference in flow rates.	$O_2$	Oxygen concentration measurement (4081 with 4073 only)
$\dot{V}_{\Delta\%}$	Flow rate delta percent – the difference in flow rates by %.	$T$	Flow tube temperature measurement.
$V_{\text{TI}}$	Inhaled tidal volume	$f$	Breath frequency
$V_{\text{TE}}$	Exhaled tidal volume	$t_i$	Inspiratory time
$V$	Real-time volume	$t_{\text{IP}}$	Inspiratory pause time
$MV$	Inhaled minute tidal volume	$t_{\text{I+P}}$	Inspiratory time including pause time
$P$	Low pressure measurement (4081 only)	$t_{\text{R}}$	Inspiratory rise time – amount of time from the start of breath to the max flow rate.
$PIP$	Peak inspiratory pressure (4081 only)	$t_{\text{E}}$	Expiratory time
$P_{\text{EEP}}$	Peak end expiratory pressure (4081 only)	$I:E$	Inspiratory to Expiratory ratio
$P_{\text{MAP}}$	Mean airway pressure (4081 only)	$I:E_{\text{IP}}$	Inspiratory to Expiratory ratio including pause time.
$P_{\text{MIN}}$	Minimum low pressure (4081 only)	$C_{\text{STAT}}$	Static compliance – calculated as Tidal volume / (plateau pressure – PEEP).
$P_{\Delta}$	Delta low pressure – Delta airway pressure (4081 only)		Time of day
$LR$	Leak rate – calculated as change in low pressure over the set Average Time		

## Available Units of Measurement

Measurement	Factory Default Units	Optional User-Selectable Units
$\dot{V}$ , $\dot{V}_{PEAK}$ , $\dot{V}_{MIN}$	L/min	mL/min, mL/s
$V_{TI}$ , $V_{TE}$ , $V$ , $MV$	L	mL, L
$P$ , $P_{IP}$ , $P_{EEP}$ , $P_{MAP}$ , $P_{MIN}$ , $P_{\Delta}$ , $P_{PLAT}$	cmH <sub>2</sub> O	kPa, Pa, hPa, mbar, mmHg, inH <sub>2</sub> O, PSI
$P_{HIGH}$	PSI	kPa, bar
$P_{ABS}$	kPa	cmH <sub>2</sub> O, Pa, hPa, mbar, bar, mmHg, PSI, inH <sub>2</sub> O
$O_2$	% oxygen	-
LR	cmH <sub>2</sub> O/s	kPa/s, Pa/s, hPa/s, mbar/s, mmHg/s, PSI/s, inH <sub>2</sub> O/s
$C_{STAT}$	mL/cmH <sub>2</sub> O	L/H <sub>2</sub> O, mL/mbar, L/mbar
T	°C	°F
f	1/min	Hz
$t_i$ , $t_{IP}$ , $t_{I+P}$ , $t_E$ , $t_R$	s	-

# Measurement Parameter Definitions

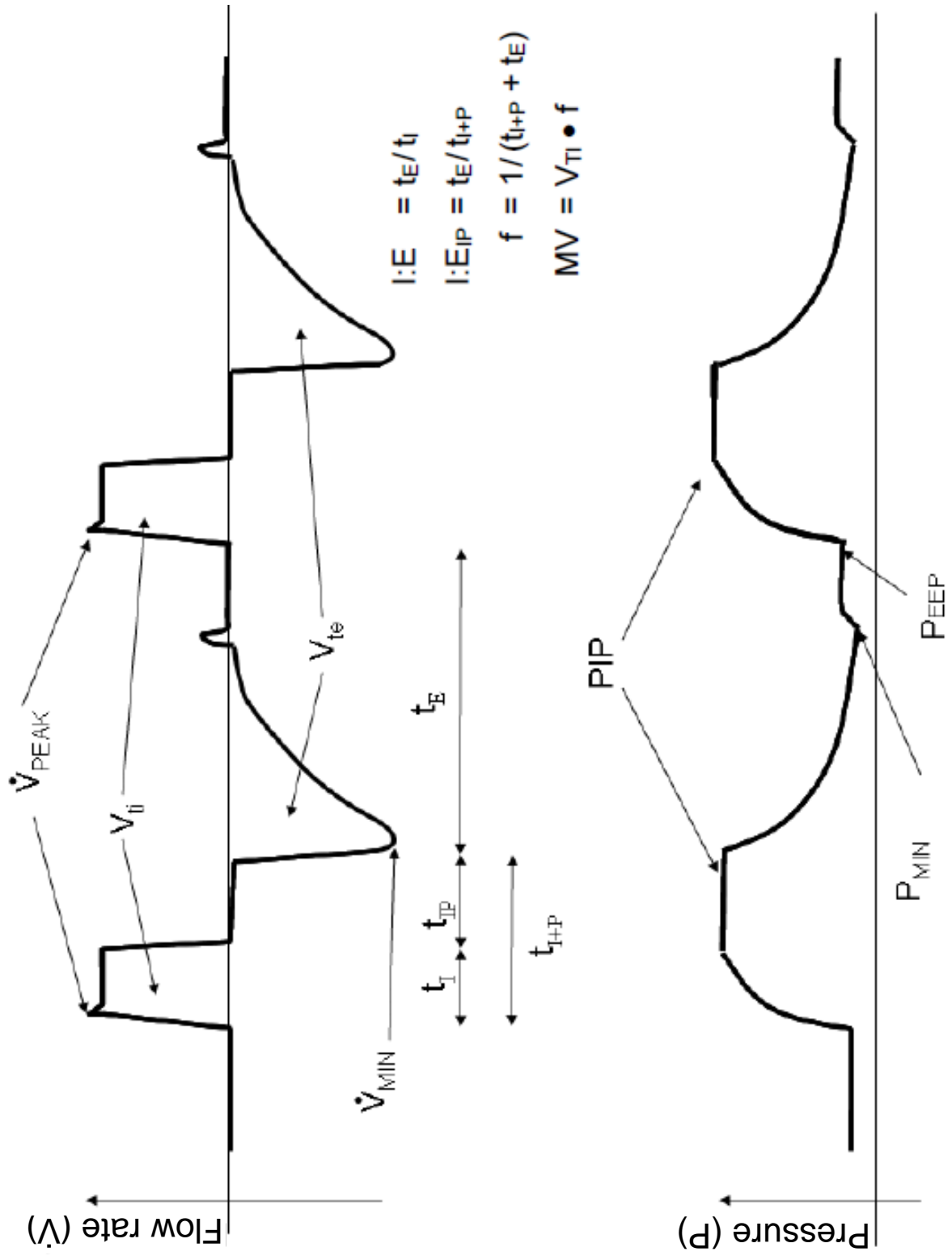

$$I:E = t_E/t_I$$

$$I:E_{IP} = t_E/t_{I+P}$$

$$f = 1/(t_{I+P} + t_E)$$

$$MV = V_T \cdot f$$

*(This page intentionally left blank)*

# Flow Analyzer Setup

---

---

## Getting Started

### Power On/Off

Press the power button located on the back of the Certifier™ Pro Flow Analyzer once to turn the instrument on. With the device powered on, press the power button once to begin the controlled shutdown procedure. The controlled shutdown will count down for 15 seconds before shutting the instrument down. During the countdown procedure, buttons are displayed to provide the options to either shut down the instrument immediately or to cancel the shutdown.

### Initialization and Warm-Up

Upon pressing the power button, the Certifier™ Pro Flow Analyzer will display a TSI® splash screen and progress bar during the bootup process. The initialization process takes approximately 40 to 45 seconds to complete. Wait for one minute after initialization has completed to allow for the pressure transducers and flow sensor to warm-up.

---

---

NOTICE
To ensure accurate measurements, wait one minute for the Certifier™ Pro Flow Analyzer to warm up. If environmental conditions have changed significantly, more time may be necessary.

---

---

## Instrument Setup

### Connect Inlet Filters

TSI® Certifier™ Flow Analyzers measure utilizing an exposed thermal flow sensor that is highly sensitive to foreign matter and particles within the gas flow. TSI® supplies inlet filters for both the high flow and low flow channels. TSI® recommends that an inlet filter be used at all times when operating the Certifier instrument.



CAUTION
To avoid damage to the Certifier Pro Test System components, always use HEPA filtration upstream of the flow channel inlets and always cap the ports when not in use.

### Connect the Low Pressure Measurement

To connect the low pressure measurement, attach the airway pressure fitting with screen to the breathing circuit. Cut a length of silicon tubing, connect one end of the tubing to the barb on the airway pressure fitting, and connect the other end of the tubing to the (+) low pressure port located at the front of the instrument.

## Breath Triggers

The Certifier™ Pro Flow Analyzer uses triggers to define start of the inspiratory and expiratory cycles. Triggers are based on the flow rate, pressure, or from a TTL voltage signal. The Certifier™ Flow Analyzer is set as its trigger default to automatically detect the breath cycles (using flow rate), but you can also set your own start and end trigger values. Under most circumstances, it is recommended to use the Auto Trigger feature.

In manual trigger mode, you select values for the start and end of the breath. A positive slope through the first value is used for the start of inspiratory and a negative slope through the second value used for the start of expiratory. To determine manual flow trigger values, it can be helpful to view the Flow Rate waveform on the Graph screen.

You have the option to set start and end triggers manually based on pressure. To determine pressure trigger values, it can be helpful to view the Low Pressure waveform on the Graph screen. The pressure trigger is intended to give advanced users additional setup options for testing high frequency ventilators or other setups in which flow rate or auto-triggering are not providing reasonable results.

Start and end of the breath can also be triggered by a TTL voltage signal connected directly to the Certifier™ instrument. The connector for TTL voltage is a 3.5 mm mono audio jack plug located on the back of the Certifier Pro Flow Analyzer labeled “Trigger In.”

---

## Connect the Certifier™ Pro to a Ventilator

Follow the steps below to connect the Certifier Pro Flow Analyzer to a bi-directional test circuit:

1. Press the power button to turn on the Certifier Pro Flow Analyzer. After bootup has completed, wait one minute for the pressure transducers and flow sensor to warm up.
2. Perform pre-test checks including zeroing the 4081 pressure transducers and calibrating the oxygen sensor (if applicable). Refer to the [Pre-Test Checks](#) section for detailed instructions.
3. Connect an inlet filter to the circuit upstream of the Certifier™ Pro Flow Analyzer.
4. Use a Y-fitting to connect the ventilator inspiratory hose to the inlet of the high flow channel on the Certifier Pro Flow Analyzer. The other end of the Y-fitting can connect to ventilator expiratory hose or could vent to atmosphere.
5. Connect the low pressure measurement by attaching the low pressure fitting to the breathing circuit. Cut a length of silicon tubing and connect one end to the (+) port of the Certifier Flow Analyzer and connect the other end to the barb on the airway pressure fitting.
6. Connect a test lung to the outlet of the Certifier Pro Flow Analyzer high flow channel.



7. Configure the Certifier Pro Flow Analyzer settings from the instrument display as specified by the manufacturer of the device under test. A Certifier Flow Analyzer user configuration could be loaded if available.
8. Perform testing per the device manufacturer's procedure (or other appropriate procedure). The manufacturer of the device under test will specify the testing requirements and pass/fail criteria.

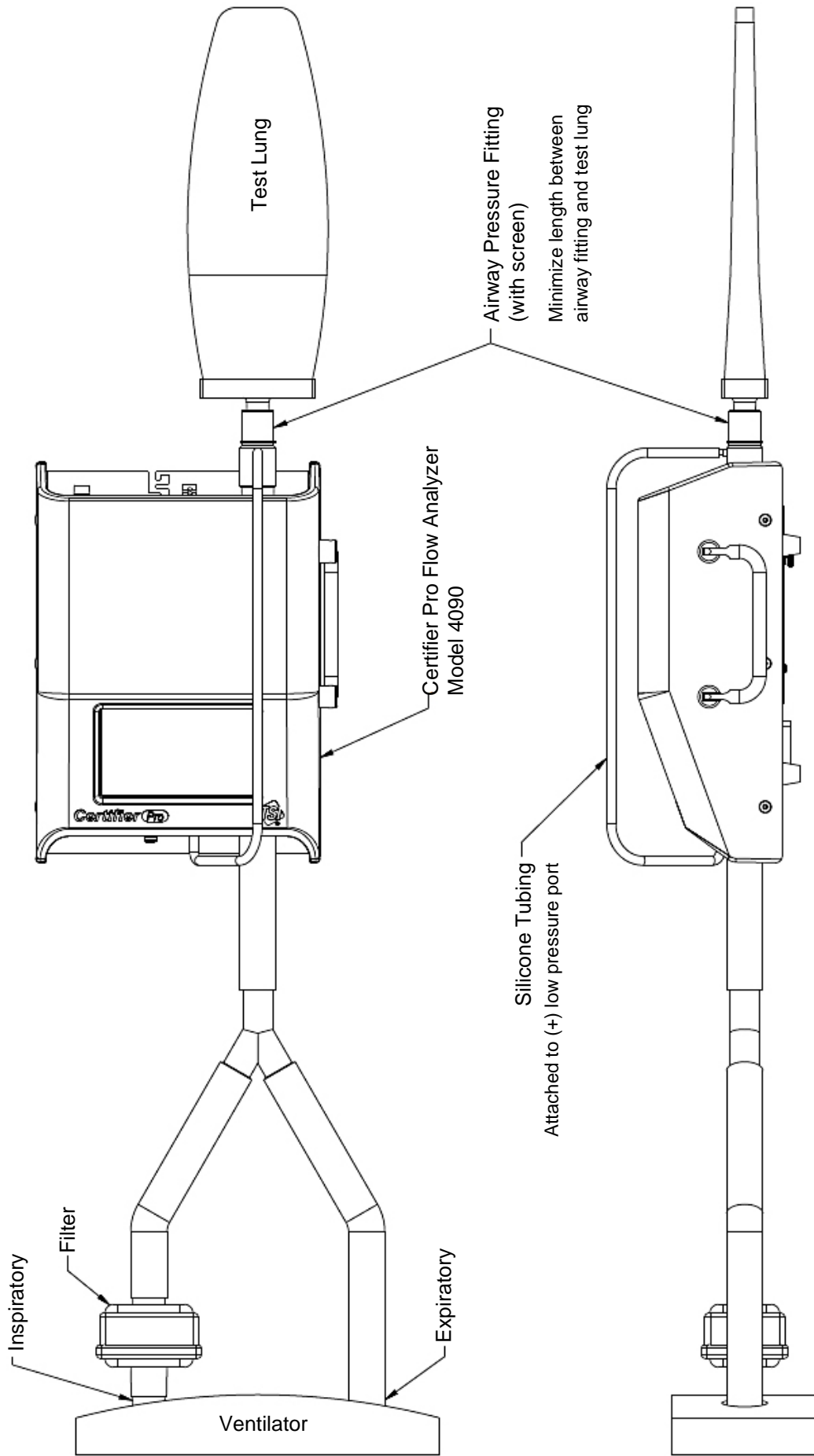

**Test circuit for bi-directional flow**

---

# Pre-Test Checks

## Flow Measurement

To ensure proper operation of the system for safety, ensure the instrument's flow calibration date is valid. If the calibration due date is approaching or past according to the factory attached label, return the instrument to TSI® for calibration. To do a quick check on the flow rate, cap both ends of the flow channels, wait one minute, and then observe the flow readings. Flow rate readings should be within  $0.000 \pm 0.010$  liters/min. If readings are outside this range, then return the instrument to TSI® Incorporated for calibration.

## Flow Direction Sensor

The high flow channel incorporates a sensor that is used to detect the direction of flow. This sensor will normally auto-zero if there is no flow for a fraction of a second. To manually zero the direction sensor, remove any source of flow from the high flow channel and cap both ends of the tube for 2-3 seconds. *No indication is given by the Certifier™ Flow Analyzer during this process.*

## Low-Pressure and High-Pressure Transducer Zeroing

Zero the low-pressure and high pressure transducers before each pressure measurement to ensure the most accurate readings. If the low or high pressure is not reading zero, perform the following steps to zero the transducers.

1. Disconnect any pressure tubing from the low pressure and high pressure ports.
2. Press the zero icon.
3. "Pressure Transducers Zeroing" appears on the display for one second. If the transducers do not see a steady pressure or near zero pressure, an error appears. *Note that the barometric pressure transducers **do not** require a zero calibration.*

## Oxygen Sensor Calibration

Follow these steps daily, following an altitude change, or sensor replacement to calibrate the oxygen sensor:

1. With an oxygen sensor installed, power on the Certifier™ Flow Analyzer and allow one minute to warm up.
2. Navigate to the **Settings** menu and select "**Oxygen Sensor**". Follow the directions on the screen. *Note that either an "air only" or "air and 100% oxygen" calibration can be done. The two point air and 100% oxygen calibrations provide the best accuracy.*

### NOTICE

The numeric value displayed during the stabilization process **does not** necessarily represent the actual oxygen concentration. This numeric stabilization value is there for you to determine if it is changing or not. Once the reading stops changing then it is time to advance to the next step in the oxygen sensor calibration process.

## Flow Compare

The Flow Compare feature provides an indication of flow accuracy by comparing the flow rate measurement of the low flow channel to the flow rate measurement of the high flow channel. The Flow Rate Delta parameter (shown below left) displays the difference in readings in a discreet value. The Flow Rate Delta Percent parameter (shown below right) displays the difference in flow rate readings as a percentage. *Note that a flow rate greater than 2.5 L/min should be used for the flow compare.*

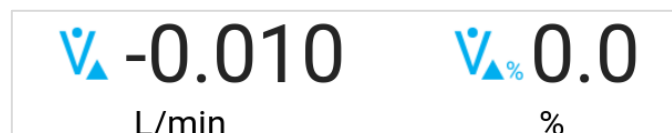



# Touchscreen Operation

## Display Interface Overview

The two primary screens on the **Dashboard** of the Certifier™ Pro Flow Analyzer are the **Parameter Screen** and the **Graph Screen**. The top, bottom, and right bars are always present on both screens. Edits made to the instrument through any of these bars apply to the entire instrument regardless of the screen in which you make changes from.

### Parameter Screen

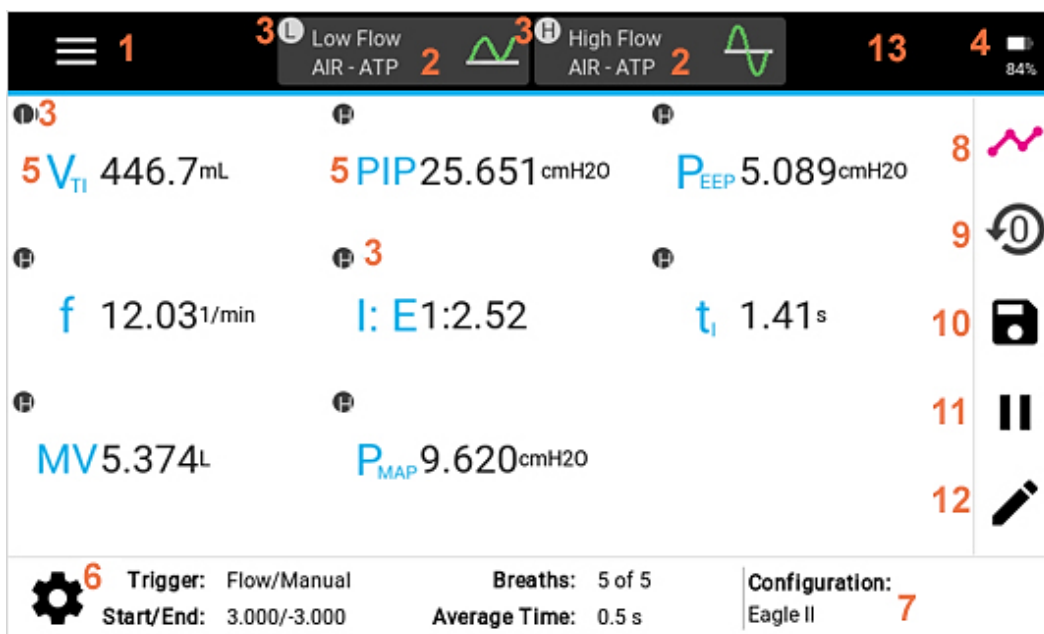

1.	Menu	8.	Parameter/Graph Screen Toggle
2.	Channel Cards	9.	Zero Pressure Sensors
3.	Channel Indicator	10.	Save Data and/or Snapshots
4.	Battery Indicator	11.	Pause/Play Display
5.	Measurement and Units	12.	Edit Measurements and/or Units
6.	Triggers/Averaging Settings	13.	Warnings and Errors Notifications
7.	User Configurations		

Option	Description
1. <b>Menu</b>	Press to access the <b>Manage Data, Configurations, Settings, and Device Information</b> screens.
2. <b>Channel Cards</b>	A card for each flow channel displays the currently set gas type and conditions. The low flow channel measures uni-directional flow, and the high flow channel measures bidirectional flows. Press a card to view information or edit the gas type or gas condition settings for that particular channel.

Option	Description
3. <b>Module Indicator</b>	An “L” in the low flow channel card and an “H” is displayed in the high flow channel card. These letters correspond to the letters displayed for each measurement and are used to signal from which flow channel the readings are made.
4. <b>Battery Indicator</b>	Displays the current charge remaining between 0 to 100%. A lightning bolt symbol will be shown inside the battery icon if the Certifier™ Pro battery is actively charging. An exclamation point will be shown inside the battery icon if the Certifier™ Pro Flow Analyzer is powered but no battery is installed.
5. <b>Measurements and Units</b>	Displays the selected measurement parameter, its current readings in the selected units, with a letter (H / L) indicating from which channel the measurement is coming. Press either the measurement symbol, reading, or units to edit. Editing includes adding, removing, or reordering measurements as well as editing the units of measurement. Refer to the table in <a href="#">Measurements and Units</a> for a complete list of selectable measurement parameters.
6. <b>Triggers/Averaging Settings</b>	Used to set the breath triggers, breath averaging, and time average for real-time values. Access these instrument settings by pressing the gear icon or by pressing directly on the value to be edited. Note that the high flow channel will be the default channel for trigger control. This means that the start and end of breaths will be determined by measurements (flow rate or low pressure) made by the high flow channel.
7. <b>Configurations</b>	Displays the name of the configuration that is currently loaded. An asterisk (*) will appear in front of the name if any settings of the currently loaded configuration have been changed by the user. Press the configuration name or label on the display to access the screen to rename, save, load, delete, export, or import configuration files.
8. <b>Parameter/Graph Screen Toggle</b>	Press to toggle the Certifier™ dashboard between the <b>Parameter</b> screen and <b>Graph</b> screen.
9. <b>Zero Pressure Sensors</b>	Touch to zero the low pressure and high pressure sensors integrated in the Certifier Pro test system. <i>The absolute pressure sensor <b>does not</b> need zeroing.</i>
10. <b>Save Data</b>	Press to log measurement data or to save a screen capture.
11. <b>Pause Display</b>	Touch to pause either the <b>Parameter</b> or <b>Graph</b> screen from updating data on the display. Even while paused, the instrument will continue to make measurements. When paused the pause icon will change into a play icon; press the play icon to resume updating the display.
12. <b>Edit Measurements</b>	Press while on the <b>Parameter</b> screen to add, remove, or reorder selected measurements and their units.
13. <b>Warnings and Errors Notifications</b>	If the Certifier™ Pro Flow Analyzer generates a warning or an error, a yellow triangle with an exclamation point will be displayed in this area. Click on this icon to open the Active Warnings and Errors screen which provides you with descriptions of the issue(s).

## Warnings and Errors

Descriptions of any active warnings or errors can be viewed in the Active Warnings and Errors screen. Errors are shown highlighted in red, whereas warnings are not highlighted. You can clear warnings manually in this screen if desired. Errors can only be cleared if you take appropriate steps to resolve the error state or if the Certifier™ Pro Flow Analyzer is powered down. It is possible that an error may shut down the Certifier™ Pro Flow Analyzer automatically if the error state is not resolved.

Possible warnings and errors displayed on the Certifier™ Pro Flow Analyzer include:

- Battery missing
- Battery faulty
- Battery is too cold to run
- Battery is too hot to run
- Battery is too cold to charge
- Battery charge is full
- Battery level is low
- Batter level is too low, powering down
- Continuous data log warning
- Continuous data log stopped
- Low disk storage space
- Failed to export to USB drive
- Error opening data log of snapshot

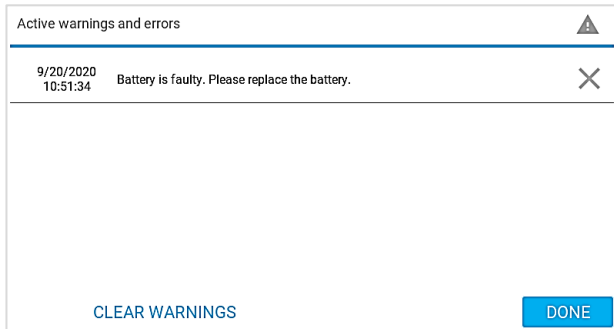

## Graph Screen

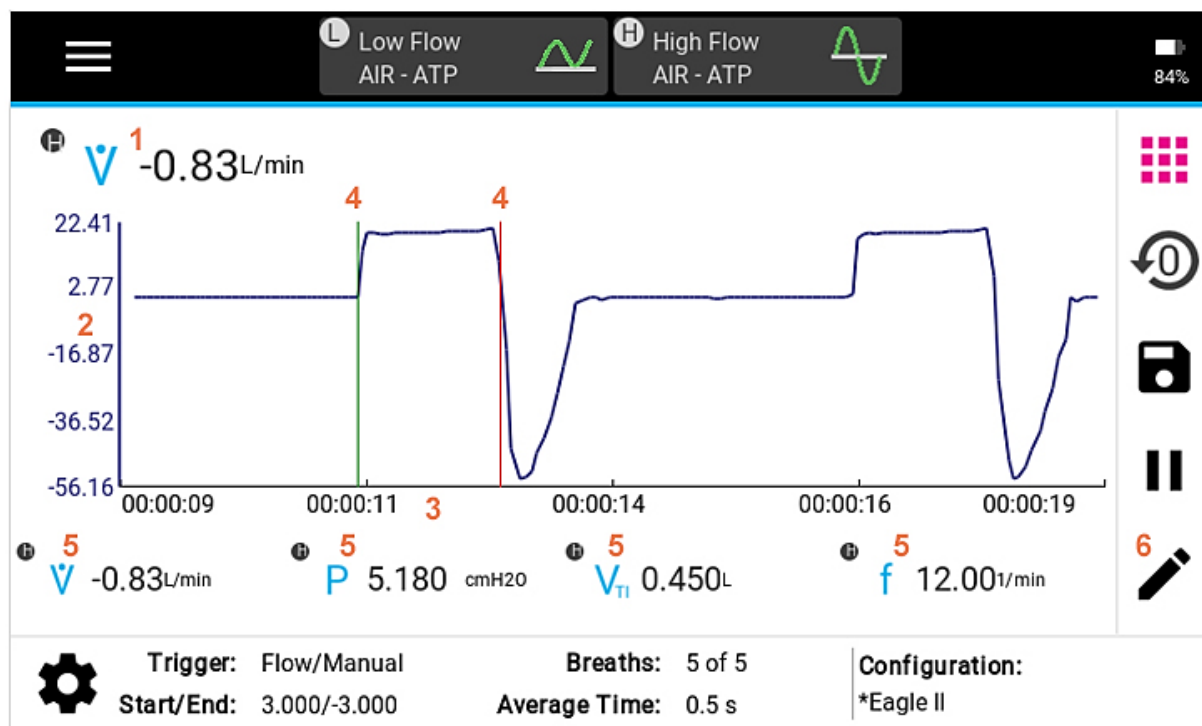

1. Plotted Measurements	4. Trigger Indicators
2. Y-Axis	5. Real-time Measurements
3. X-Axis	6. Edit Graph

Option	Description
1. <b>Plotted Measurements</b>	Displays current values for the selected measurements and their units and plots the measurement on the graph. You can graph up to two measurements at a time. Press either the measurement symbol, reading, or units to edit elements of the graph screen.
2. <b>Y-Axis</b>	Scaling is displayed in the same units as those selected for the plotted measurement. The color of the axis matches the color of the corresponding measurement parameter. With 2 measurements plotted, a second Y-axis will be displayed on the right side of the graph, colored for that measurement. The Y-axes are not clickable.
3. <b>X-Axis</b>	Scaling is displayed in seconds of time for all plotted measurements. The X-axis is not clickable.
4. <b>Trigger Indicator</b>	If enabled, the trigger timing being used by the Certifier™ Flow Analyzer to define the breath cycles will be shown on the graph as vertical lines. The first (green) line indicates the start of the inspiratory breath phase, and the second (red) line indicates the start of the expiratory breath phase.
5. <b>Real-time Measurements</b>	Up to four measurements can be selected to display their real-time values beneath the graph. Press on the measurements or units to edit the graph screen.
6. <b>Edit Graph</b>	Press while on the <b>Graph</b> screen to edit elements of the graph including plotted measurements and units, axis scaling, display span, trigger time, and displayed measurements.

### NOTICE

See the [Parameter Screen](#) section above for descriptions of screen elements not included here.

## Channel Cards

A card is shown in the black header bar for both the high flow and low flow channels. Upon pressing a channel card, you will be able to edit gas type or gas condition settings for that particular module.

Gas Type options available on the Certifier™ Pro Flow Analyzer:

- Air
- Oxygen
- Air/Oxygen Mix (with oxygen sensor connected)
- Carbon Dioxide
- Nitrous Oxide
- Nitrogen

Gas Conditions options available on the Certifier™ Pro Flow Analyzer:

Option	Description
<b>ATP</b>	<b>Actual Temperature and Pressure.</b> The gas flow rate and volumes at the actual temperature and pressure of the gas. ATP is the default gas condition for the Certifier™ Flow Analyzer.
<b>STP</b>	<b>Standard Temperature and Pressure.</b> The gas flow rate and volumes are displayed in terms of what the gas flow rate and volume would be if the gas was 21 °C and 1 atmosphere (101.3 kPa) of pressure.
<b>BTPS</b>	<b>Body Temperature and Pressure Saturated.</b> The gas flow rate and volumes are displayed in terms of what the gas flow rate and volume would be if the gas was changed to 37 °C, the actual pressure, and also saturated with water vapor.
<b>BTPD</b>	<b>Body Temperature and Pressure Dry.</b> The gas flow rate and volumes are displayed in terms of what the gas flow rate and volume would be if the gas was changed to 37 °C, but maintaining the actual pressure.
<b>USTP</b>	<b>User Standard Temperature and Pressure.</b> The gas flow rate and volumes are displayed in terms of what the gas flow rate and volume would be if the gas was at the conditions specified by user.

The Reverse Flow toggle can be used to change the high flow channel from bidirectional to uni-directional flow sensing.

NOTICE
A toggle change results in an application reboot to apply changes.

## Menu Screen

The menu can be accessed from either the **Parameter** screen or **Graph** screen.

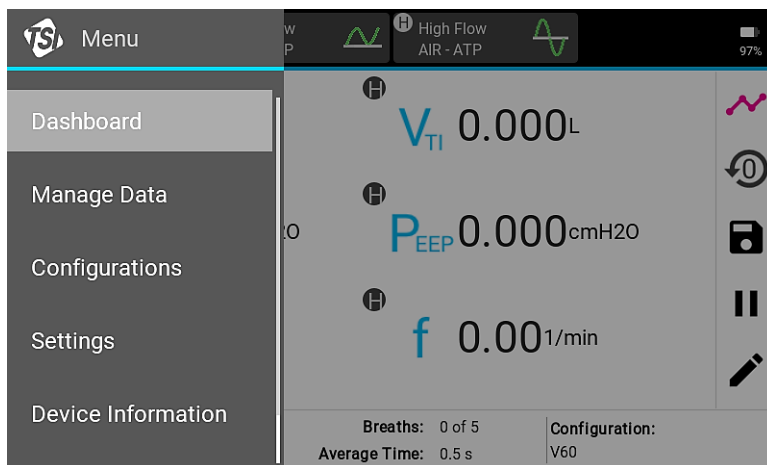

Menu	Description
<b>Dashboard</b>	Closes the <b>Menu</b> options and returns you to the previous screen.
<b>Manage Data</b>	Enters screen where you can organize, preview, export, and delete saved data.
<b>Configurations</b>	Used to save, load, export, import, rename, and delete Certifier™ configuration files.
<b>Settings</b>	Access general, date, time, and display brightness settings or calibrate an oxygen sensor.
<b>Device Information</b>	Displays model, serial number, firmware version and last calibration date for the interface module plus any connected modules.

## Configuring the Analyzer

### Measurements and Units

From the **Parameter** screen, access the measurement selection screen by pressing on any of the currently displayed measurement symbols, readings, or units of measurement, or by pressing the pencil icon in the right navigation bar.

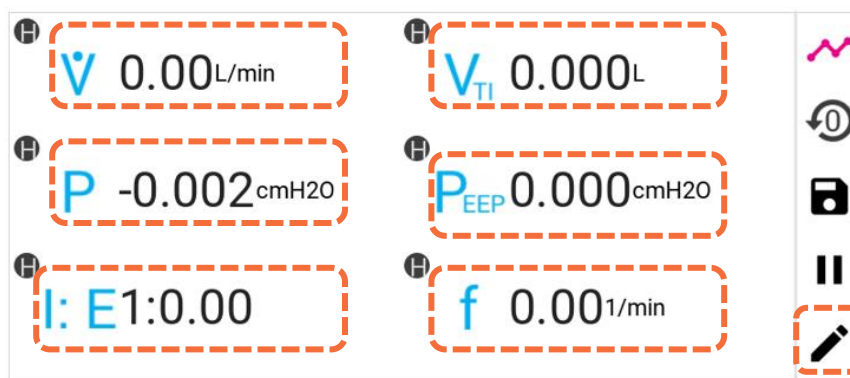

Press the (+) **ADD** tile to select an additional measurement, or press the measurement symbol of a currently selected measurement to change that measurement parameter.



Once pressed, a list of available measurements will be displayed in alphabetical order (see below left). An H is displayed in the upper left to indicate the measurement is coming from the high flow channel, and an L is displayed for measurements coming from the low flow channel. Swipe up and down to scroll through the list options, tap to select.

To change the units of measurement for a parameter, press on the currently selected units to access a drop-down list of available alternatives (see below right). Refer to the table [Available Units of Measurement](#) to see all the available units for each measurement.

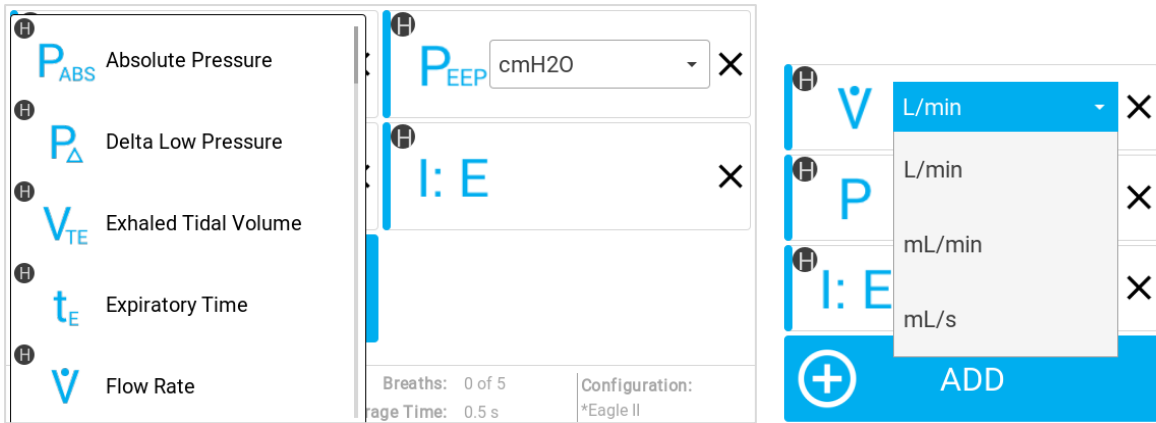

To reorder the selected measurements, press and hold a measurement tile to be able to drag it around the display. The other tiles will adjust on the screen as the tile is being dragged, release the tile once the desired position has been reached.



To remove a measurement from being displayed on the **Parameter** screen, press the **X** located next to the units for that measurement.

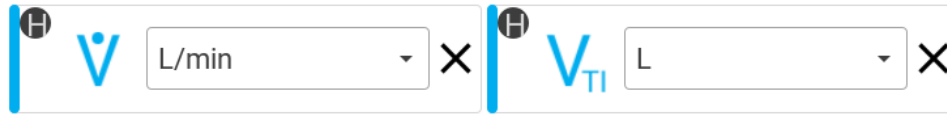

Press the orange **X** button in the right navigation bar at any time to disregard all changes and return to the **Parameter** screen.



Press the green **✓** checkmark button in the right navigation bar to save changes and returns you to the **Parameter** screen.

## Gas Type and Gas Condition

The active gas type and gas condition is displayed on the flow channel cards located in the top black bar on the screen. Press anywhere on a channel card to edit the settings for that particular channel.



Press the **Gas Type** field to display the list of available gases and to select a gas. Gas Type options available on the Certifier™ Pro Flow Analyzer include: Air, Oxygen, Air/Oxygen Mix (with oxygen sensor connected), Carbon Dioxide, Nitrous Oxide, and Nitrogen.

A **Reverse Flow** toggle switch is available on the high flow channel. Press the Reverse Flow toggle to change the high flow channel from bidirectional to uni-directional flow sensing.

### NOTICE

The application will reboot after saving a toggle change in order to apply the change.

Press the radio buttons to select a **Gas Condition** to apply to the flow measurements.

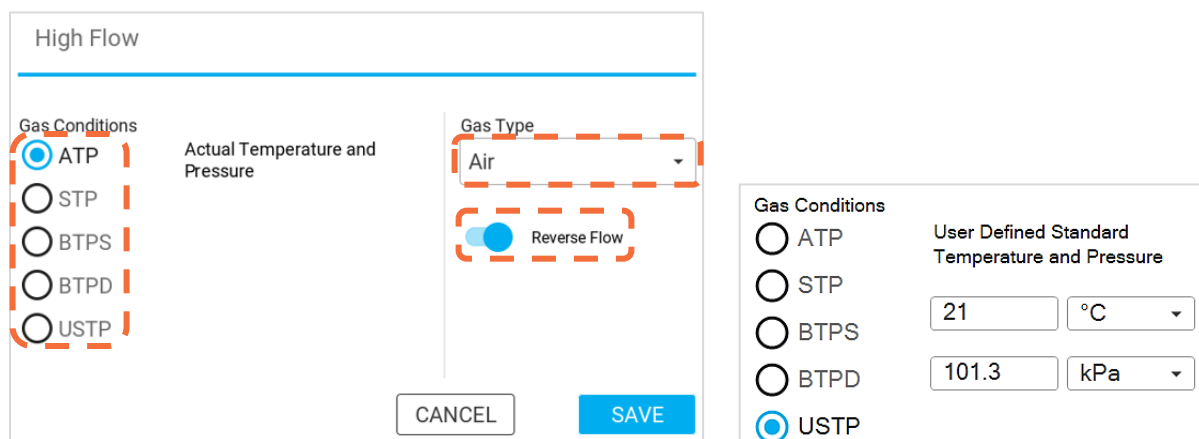

To specify your own temperature and pressure values and apply those conditions to gas flow measurements, select the **USTP** gas condition option (shown above right).

Press the **SAVE** button to apply changes to the gas type or gas conditions. Press **CANCEL** to disregard changes and return to the previous screen.



Gas condition options available on the Certifier™ Flow Analyzer:

Option	Description
<b>ATP</b>	<b>Actual Temperature and Pressure.</b> The gas flow rate and volumes at the actual temperature and pressure of the gas. ATP is the default gas condition for the Certifier™ Flow Analyzer.
<b>STP</b>	<b>Standard Temperature and Pressure.</b> The gas flow rate and volumes are displayed in terms of what the gas flow rate and volume would be if the gas was 21 °C and 1 atmosphere (101.3 kPa) of pressure.
<b>BTPS</b>	<b>Body Temperature and Pressure Saturated.</b> The gas flow rate and volumes are displayed in terms of what the gas flow rate and volume would be if the gas was changed to 37 °C, the actual pressure, and also saturated with water vapor.
<b>BTPD</b>	<b>Body Temperature and Pressure Dry.</b> The gas flow rate and volumes are displayed in terms of what the gas flow rate and volume would be if the gas was changed to 37 °C, but maintaining the actual pressure.
<b>USTP</b>	<b>User Standard Temperature and Pressure.</b> The gas flow rate and volumes are displayed in terms of what the gas flow rate and volume would be if the gas was at the conditions specified by user.

## Breath Triggers

Triggers are used to detect the start of the inspiratory and expiratory breath cycles. Triggers can be based on the flow rate, pressure, or from a TTL voltage signal. The Certifier™ Flow Analyzer can automatically detect the breath using the flow rate. You can also manually set your own start and end trigger values using the flow rate or low pressure.

As the default, triggers are controlled by the high flow channel. Power the high flow channel down (see page 4-31) to change trigger control to the low flow channel.

Access the Triggers screen by pressing on the currently selected trigger or the gear icon from the dashboard of the Certifier™ Flow Analyzer. Triggers can also be accessed through the Menu by selecting Settings and then the Triggers and Averaging option.

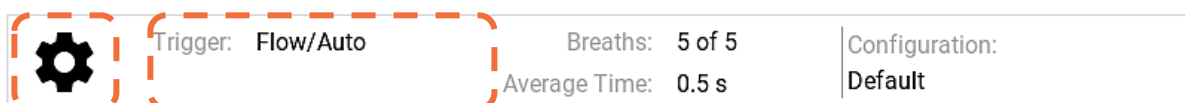

## Flow Rate – Auto Triggers

The Certifier™ Flow Analyzer default is to trigger automatically using the flow rate from the high flow channel. Under most circumstances, it is recommended to use the **Auto Trigger** feature. In Auto Trigger mode, the Certifier Flow Analyzer will use the flow rate to detect the waveform and automatically assign the start of the inspiratory phase and expiratory phase for each breath.

### NOTICE

The Graph Screen can display trigger timing indicators so that you may see the approximate values that the Certifier Flow Analyzer is using for triggers.

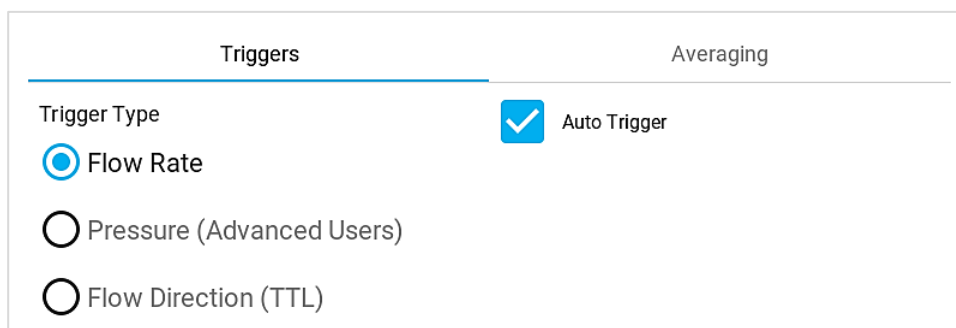

### Flow Rate – Manual Triggers

If auto-triggering is not providing reasonable results, consider using manual flow triggering. Press the **Auto Trigger** box to unselect it and be able to specify flow rate values for the start and end of the breath. A positive slope through the first value is used for the start of inspiratory and a negative slope through the second value used for the start of expiratory. For robust triggering, always set the “**End**” level lower than the “**Start**” level.

To optimize manual flow trigger values, it can be helpful to view the **Flow Rate** waveform plotted on the Certifier™ **Graph** screen or observe the flow waveform from the ventilator being tested. Refer to section [Editing the Graph Screen](#) for more information on graphing waveforms.

Trigger Type	<input type="checkbox"/> Auto Trigger
<input checked="" type="radio"/> Flow Rate	Start
<input type="radio"/> Pressure (Advanced Users)	<input type="text" value="1"/> L/min ▾
<input type="radio"/> Flow Direction (TTL)	End
	<input type="text" value="-1"/> L/min ▾

### Pressure – Manual Triggers

This trigger type is intended to give advanced users additional setup options for testing high frequency ventilators or other setups for which flow rate triggers are providing reasonable results. *Note that auto-triggering is not available for pressure.*

To trigger using the low pressure, select the **Pressure** radio button option. A positive slope through the first value is used for the start of inspiratory and a negative slope through the second value used for the start of expiratory. For robust triggering, always set the “**End**” level lower than the “**Start**” level.

To optimize manual pressure trigger values, it can be helpful to view the **Low Pressure** waveform plotted on the **Graph** screen or observe the pressure waveform from the ventilator being tested. Refer to section [Editing the Graph Screen](#) for more information on graphing waveforms.

Trigger Type	Start
<input type="radio"/> Flow Rate	<input type="text" value="5"/> cmH2O ▾
<input checked="" type="radio"/> Pressure (Advanced Users)	End
<input type="radio"/> Flow Direction (TTL)	<input type="text" value="6"/> cmH2O ▾

## TTL Trigger

The start and end of the breath can also be triggered by a TTL voltage signal given at the connector on the Certifier™ Pro High Flow Module labeled “**Trigger Input**”. This is only available for the 4081 High Flow Module. The connector is a 3.5 mm mono audio jack plug. To trigger using TTL voltage, select the **Flow Direction (TTL)** radio button option and select the TTL voltage.

Trigger Type	Trigger
<input type="radio"/> Flow Rate	TTL Low (0 Volts) ▾
<input type="radio"/> Pressure (Advanced Users)	TTL Low (0 Volts)
<input checked="" type="radio"/> Flow Direction (TTL)	TTL High (+5 Volts)

## Averaging

Access the **Averaging** screen by pressing on the area around the **Breaths** and **Averaging Time** fields or gear icon located at the bottom of the screen. Averaging can also be accessed through the Menu by selecting **Settings** and then the **Triggers** and **Averaging** option.

	Trigger: Flow/Auto	Breaths: 5 of 5 Average Time: 0.5 s	Configuration: Default
---	--------------------	--	---------------------------

### Number of Breaths

This setting specifies the maximum number of breaths over which to average the breathing parameter measurements. For example, if the number of breaths is set to 5, but only 3 breaths have been detected so far, all 3 breaths will be used in calculating the breathing parameters. In the same scenario, if 7 breaths have been detected, only the most recent 5 breaths would be used in the calculations. To specify the number of breaths, touch the input field and enter a whole number ranging from 1 to 10 breaths.

### Time Average for Real-Time Values

The time average sets the rate at which real-time values are averaged and updated on the display. For example, with a time average value of 0.5 second, the incoming data is averaged over a 0.5 second period and updated on the display every 0.5 seconds. Real-time values include measurements for flow rate, low pressure, high pressure, absolute pressure, oxygen concentration, and temperature. To specify the time average, touch the input field and enter a value ranging from 0.5 to 10 seconds.

Triggers	Averaging
Number of Breaths	
<input type="text" value="5"/>	
Time Average for Real-Time Value	
<input type="text" value="0.5"/> s	

# Using Configurations

A configuration is a collection of Certifier™ Flow Analyzer settings that can be saved to internal memory and later recalled. This allows you to save and use specific setups to test different equipment, to comply with organizational test standards, or for personal preferences. Configurations record the measurements and units selected, gas calibrations, gas conditions, triggers and averaging, and graph setup.

The active configuration is displayed at the bottom right of the **Parameter** and **Graph** screens. Access the **Configurations** screen by pressing anywhere in the Configuration area in the bottom right corner of the screen. **Configurations** can also be accessed through the Menu by selecting the **Configurations** menu option.

Trigger: Flow/Auto

Average Time: 0.5 s

Breaths: 5 of 5

Configuration:

Default

NOTICE

An asterisk will be displayed in front of the configuration name to indicate that the settings have been changed and differ from what is saved in the original configuration. The asterisk will be removed if the Certifier™ Flow Analyzer is changed back to the original configuration settings or if the configuration is reloaded. You also have the option to save the current settings and changes, either overwriting the currently loaded configuration or creating a new configuration.

Trigger: Flow/Auto

Average Time: 0.5 s

Breaths: 0 of 5

Configuration:

\*One

## Managing Configurations

The Local Configurations tab lists all the individual configuration files saved in the Certifier™ Pro Flow Analyzer's internal memory. The Certifier™ Pro Flow Analyzer can save up to 20 different user configurations. The currently loaded configuration will be highlighted blue in the list (ex. Default). Swipe up and down on the list to scroll through the files.

The 3-dot icons provide the options to **Rename**, **Save**, **Load**, **Export**, or **Delete** individual configuration files. Press the 3-dot icon of individual configuration file rows to perform an action.

Local Configurations			External Configurations			
	Name	Trigger	Ave	Breaths	Gas Type	Actions
<input type="checkbox"/>	Default	Flow/Auto	0.5 s	5		⋮
<input type="checkbox"/>	840	Flow/Auto	0.5 s	5		⋮
<input type="checkbox"/>	E360	Flow/Auto	0.5 s	5		⋮
<input type="checkbox"/>	G5	Flow/Auto	0.5 s	5		⋮
<input type="checkbox"/>	Model 980	Flow/Auto	0.5 s	2		⋮

The check boxes are used to select multiple files so you may export or delete more than one configuration at a time. Press a check box to select and press again to deselect. Press the checkbox in the **Name** column heading to select all configuration files.

**NOTICE**

The Default configuration file **cannot** be overwritten, renamed, exported, or deleted.

Local Configurations			External Configurations			
<input checked="" type="checkbox"/>	Name	Trigger	Ave	Breaths	Gas Type	Actions
<input checked="" type="checkbox"/>	840	Flow/Auto	0.5 s	5		⋮
<input type="checkbox"/>	Default	Flow/Auto	0.5 s	5		⋮
<input checked="" type="checkbox"/>	E360	Flow/Auto	0.5 s	5		⋮
<input checked="" type="checkbox"/>	G5	Flow/Auto	0.5 s	5		⋮
<input checked="" type="checkbox"/>	Model 980	Flow/Auto	0.5 s	2		⋮

### Loading Configurations

Locate the configuration in the list under **Local Configurations** and press the 3-dot icon for the file row. Select the **Load** option from the pop-up menu.

**NOTICE**

Only one configuration can be loaded and active on the Certifier™ Flow Analyzer at a time, the check boxes are not used for loading configurations.

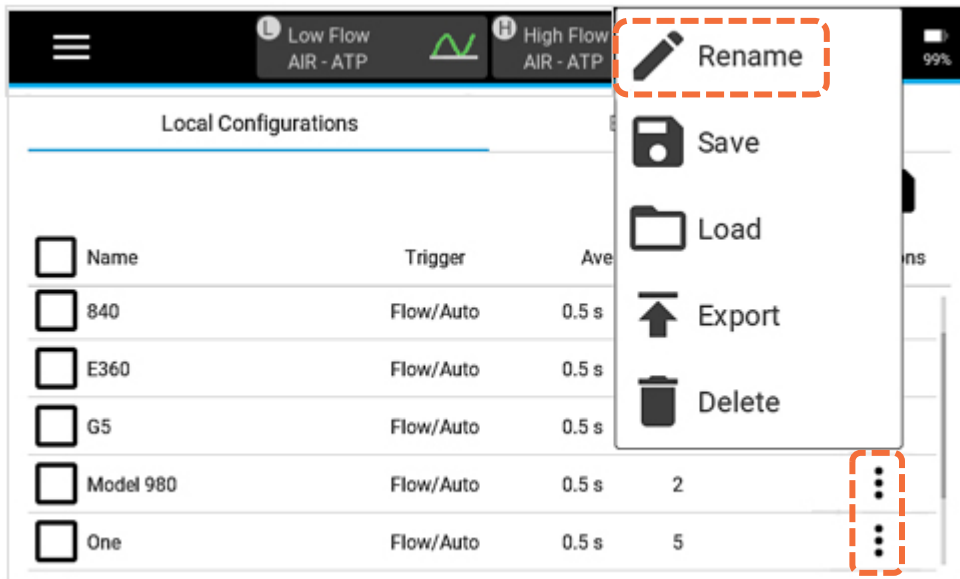

## Saving Configurations

To save the current Certifier™ Pro Flow Analyzer setup as a configuration, navigate to the **Local** tab of the **Configurations** screen and click the save (disk) icon. A pop-up screen provides the options to overwrite the active configuration [**SAVE**] or to create a new configuration [**NEW**].

**NOTICE**

Only one configuration file can be saved at a time, the check boxes are not used for saving configurations.

As an alternative, from the **Configuration** screen you can choose to save your current setup by overwriting an existing configuration on the Certifier™ Pro Flow Analyzer. Locate the configuration to be overwritten and press the corresponding 3-dot icon. A pop-up screen will ask for confirmation before overwriting the selected configuration file.

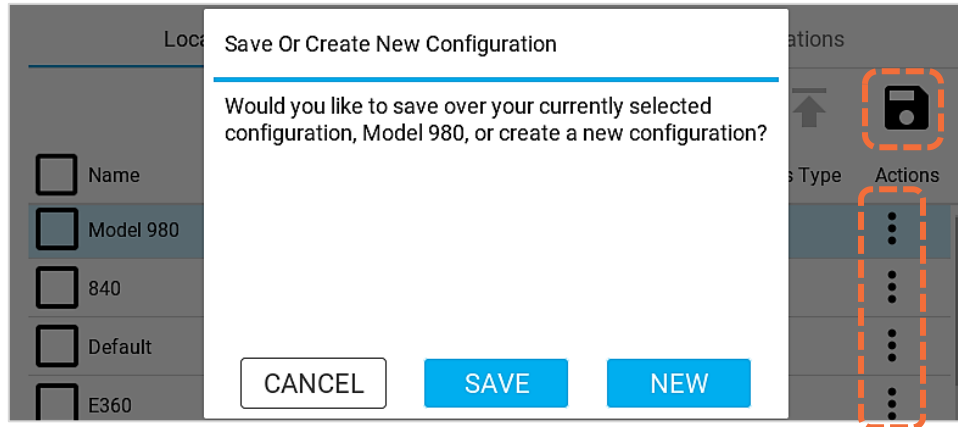

If you choose to create a new configuration to save the setup, the Certifier™ Flow Analyzer will generate a new configuration named **“New Configuration.”** To rename the new configuration, press the 3-dot menu and select the **Rename** option. Press on the text field in the **Edit Configuration** pop-up screen to bring up the onscreen keyboard. Press the blue and white **X** to the right of the configuration name to clear the text in the name field. After editing the name, press the white on blue **✓** checkmark button in the bottom right of the keyboard.

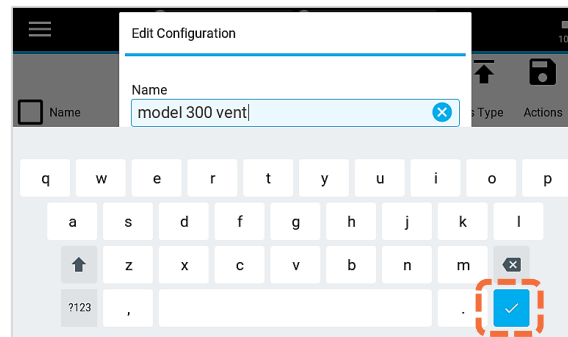
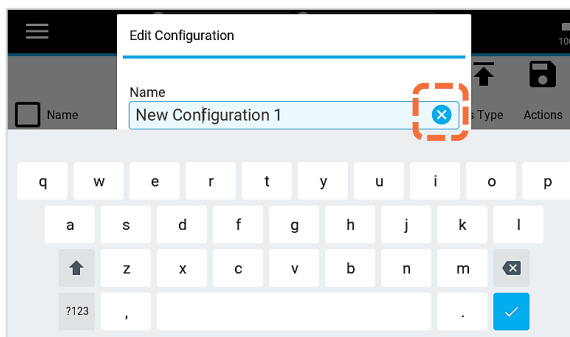

## Exporting Configurations

Configurations are stored in the internal memory of the Certifier™ Pro Flow Analyzer and can be exported from either of the two USB-A ports located on the back of the instrument. To export one or more configurations, insert a USB flash drive into the Certifier™ Flow Analyzer and navigate to the **Local** tab of the **Configurations** screen. Any existing Certifier™ configurations stored on the USB flash drive will be displayed in the **External Configurations** tab.

To export a single configuration, either click on the 3-dot menu of that particular configuration file and select the **Export** menu option, or check the corresponding box and press the export icon (up arrow).

To export more than one configuration, press the check box for each configuration file or press the checkbox in the **Name** column heading to select all configuration files.

### NOTICE

The Default configuration file **cannot** be overwritten, renamed, exported, or deleted.

Local Configurations			External Configurations			
<input checked="" type="checkbox"/>	Name	Trigger	Ave	Breaths	Gas Type	Actions
<input checked="" type="checkbox"/>	model 300 vent	Flow/Manual	0.5 s	5		⋮
<input checked="" type="checkbox"/>	840	Flow/Auto	0.5 s	5		⋮
<input type="checkbox"/>	Default	Flow/Auto	0.5 s	5		⋮
<input checked="" type="checkbox"/>	E360	Flow/Auto	0.5 s	5		⋮
<input checked="" type="checkbox"/>	G5	Flow/Auto	0.5 s	5		⋮

Icons above the table: a trash can, an up arrow (highlighted with a dashed orange box), and a floppy disk.

After configurations have been exported, you can navigate to the **External Configurations** tab to confirm that configuration files have successfully exported to the inserted USB drive. Exported configuration files can be attached in emails and imported into other Certifier™ Pro Model 4090 or Certifier™ Plus Model 4089 instruments.

## Importing Configurations

The Certifier™ Pro Flow Analyzer can import configurations from a USB flash drive inserted into either of the two USB-A ports located on the back of the instrument. The Certifier™ Flow Analyzer will recognize any configuration files and display them in the **External Configurations** tab.

To import a single configuration, either click on the 3-dot menu of that particular configuration file and select the **Import** menu option, or check the corresponding box and press the export icon (down arrow).

To import more than one configuration, press the check box for each configuration file or press the checkbox in the **Name** column heading to select all configuration files.

Local Configurations		External Configurations				
<input type="checkbox"/>	Name	Trigger	Ave	Breaths	Gas Type	Actions
<input type="checkbox"/>	model 300 vent	Flow/Manual	0.5 s	5		⋮
<input type="checkbox"/>	840	Flow/Auto	0.5 s	5		⋮
<input type="checkbox"/>	E360	Flow/Auto	0.5 s	5		⋮
<input type="checkbox"/>	G5	Flow/Auto	0.5 s	5		⋮

Configuration files can be exported and imported between Certifier™ Pro and Certifier™ Plus instruments.

### NOTICE

Configuration files from a Certifier™ FA+ Model 4088 are not compatible with the Certifier Pro and Certifier Plus instruments. You would need to perform a one-time replication of the settings on a Certifier Pro or Certifier Plus Flow Analyzer and save the new configuration.

## Editing the Graph Screen

From the **Graph** screen, press on the pencil icon or on any displayed measurement symbols, readings, or units to access the edit graph screen.

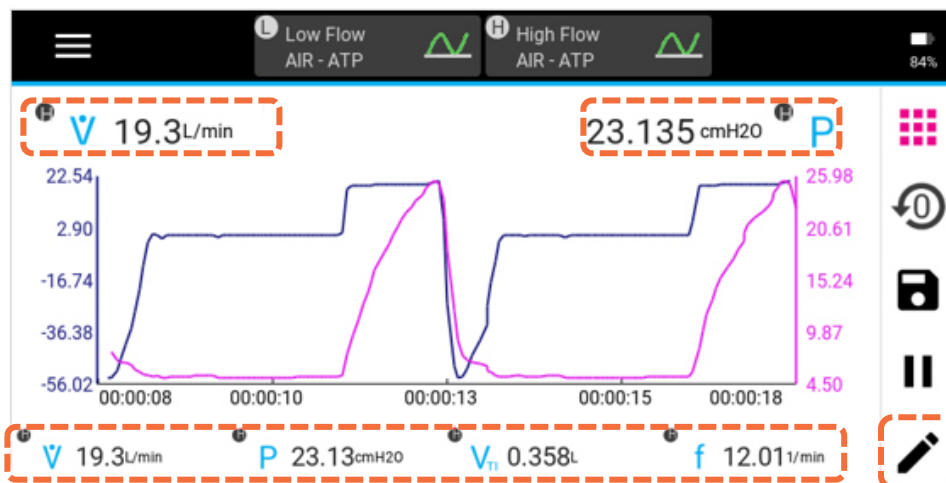



## Plotted Measurements

Either 1 or 2 measurements can be plotted on the graph at a time. The primary measurement is displayed on the left side of the screen and the secondary measurement on the right. The color of the borders around the plotted measurements in the edit screen correspond to the colors shown for the Y-axes and traces on the graph.

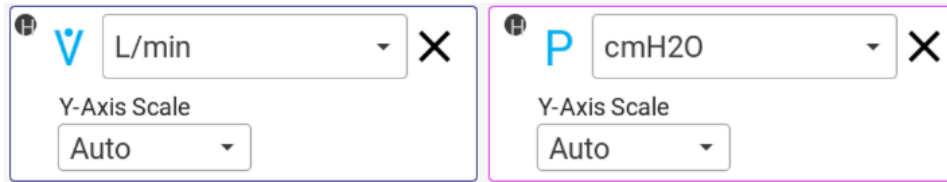

To change a measurement parameter, press on the measurement symbol to display a list of available measurements in alphabetical order (see below left). An H is displayed in the upper left to indicate the measurement is coming from the high flow channel, and an L is displayed for measurements coming from the low flow channel. Swipe up and down to scroll through the list options, and tap to select.

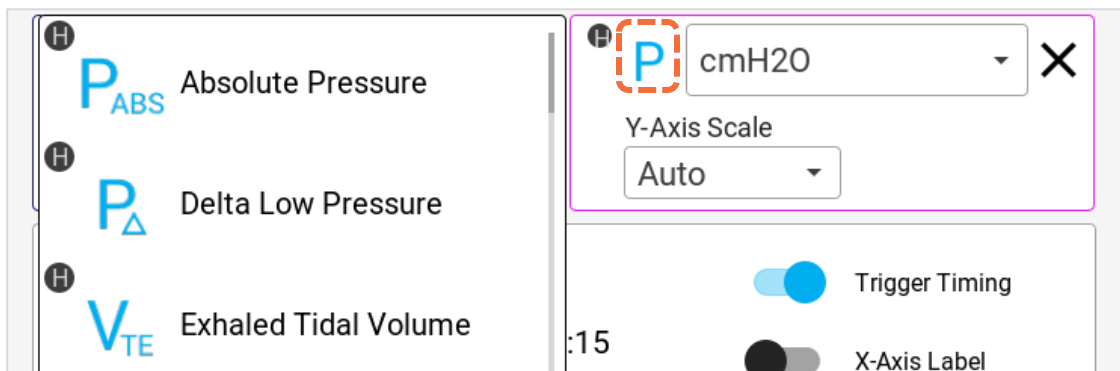

To change the units of measurement for a plotted measurement, press on the current units to access a drop-down list of available alternatives. Refer to the table [Available Units of Measurement](#) to see all the available units for each measurement.

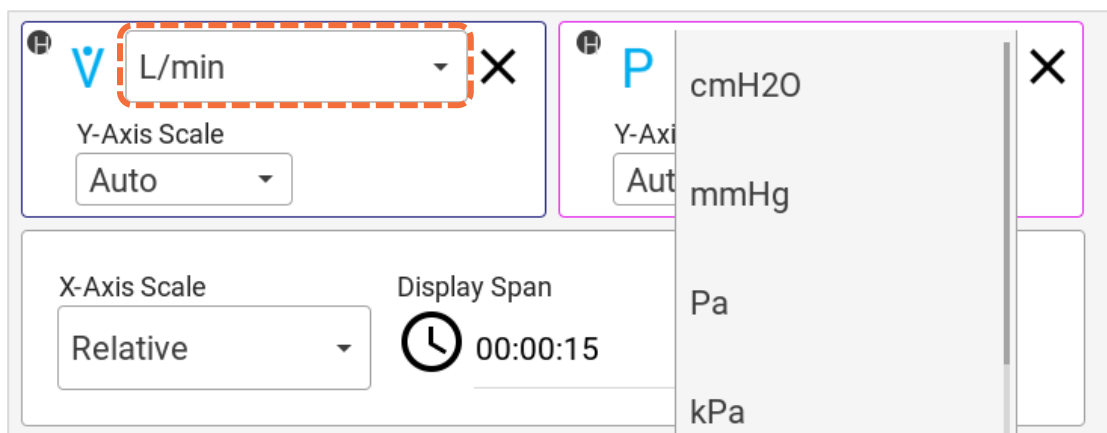

To remove a measurement from being plotted on the graph, press the X located next to the units for that measurement.

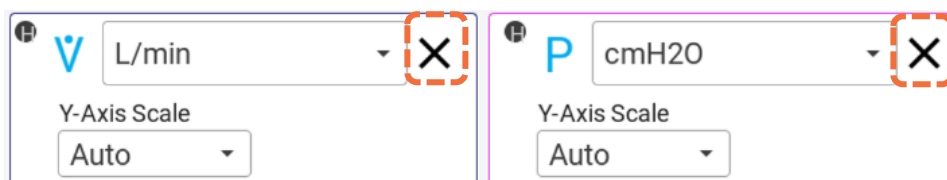

## Y-Axis Scaling

Scaling for the Y-axis is displayed in the same units as those selected for the plotted measurement. The color of the borders around the Y-Axis Scales in the edit graph screen correspond to the colors shown for the Y-axes and traces on the graph.

The Y-axis is set to scale automatically as the default. With auto-scaling, the graph will automatically adjust the Y-axis minimum and maximum values. You can choose manual scaling for Y-axes and input the minimum and maximum values to be displayed on the graph. The values input for manual **Min** and **Max** use the same units of measurement as the plotted parameter.

The image shows two side-by-side control panels for Y-axis scaling. The left panel, outlined in blue, is for a parameter labeled 'V' (blue) with units 'L/min'. It has a 'Y-Axis Scale' dropdown set to 'Manual', a 'Min' input field with '0', and a 'Max' input field with '5'. The right panel, outlined in pink, is for a parameter labeled 'P' (blue) with units 'cmH2O'. It has a 'Y-Axis Scale' dropdown set to 'Auto'.

## X-Axis Scaling

The X-axis is displayed in seconds of time for all plotted measurements. The **Display Span** specifies the length of time to display data on the graph at one time. The display span ranges from 1 to 60 seconds with the default set as 15 seconds.

The image shows a control panel for X-axis scaling. It includes an 'X-Axis Scale' dropdown menu set to 'Relative'. To its right is a 'Display Span' control with a clock icon and the value '00:00:15'. Further right are two toggle switches: 'Trigger Timing' (which is turned on) and 'X-Axis Label' (which is turned off).

The **X-Axis Label** provides the option to display or hide the X-axis on the Graph screen. The X-axis is always shown on the graph in seconds of time using HH:MM:SS format.

The **Relative X-Axis Scale** option sets the X-axis to count in seconds and use that value as the maximum for graph. For example, with the **Relative** option selected and a display span of 15 seconds, the graph X-axis will count 00:00:15, 16, 17, 18, etc., as the maximum and 15 seconds less 00:00:00, 01, 02, 03, etc., as the minimum values on the graph.

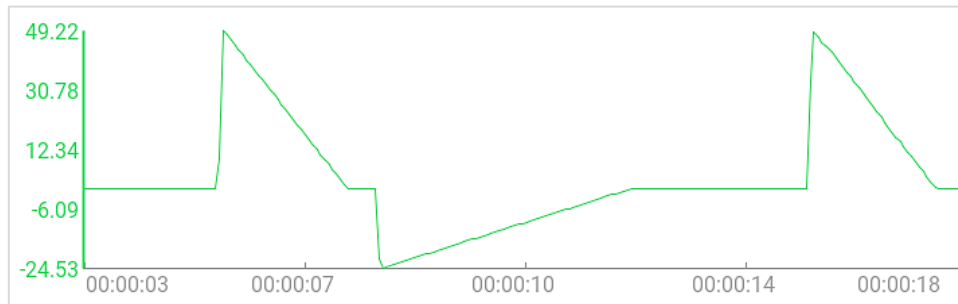

The **Span** option does not count the time and retains the beginning and end of the display span. For example, with the **Span** option selected and a display span of 15 seconds, the graph will show 00:00:00 as the minimum and 00:00:15 as the maximum for the X-axis.

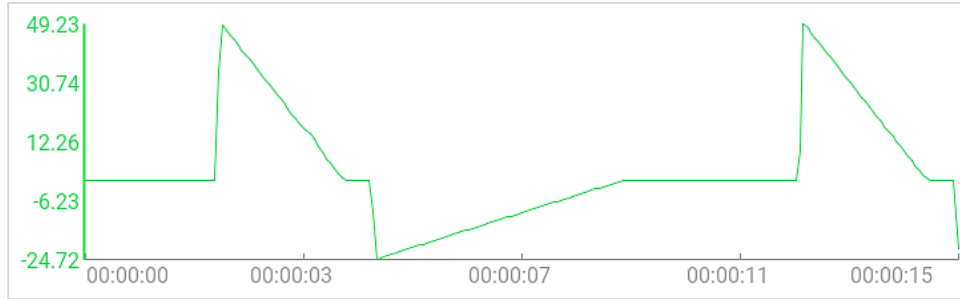

## Trigger Indicators

When enabled, the trigger timing being used by the Certifier™ Flow Analyzer to define the breath cycles will be shown on the graph as vertical lines. The first (green) line indicates the start of the inspiratory phase, and the second (red) line indicates the start of the expiratory phase of the breath cycle.

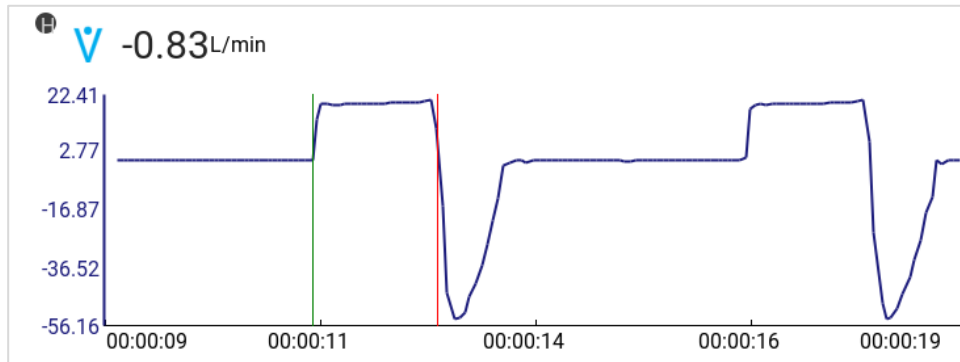

## Real-Time Measurements

Up to four measurements can be selected to display their real-time values beneath the graph. To change a measurement parameter in the edit graph screen, press on the measurement symbol to display a list of available measurements in alphabetical order (see below left). An H is displayed in the upper left to indicate the measurement is coming from the high flow channel, and an L is displayed for measurements coming from the low flow channel. Swipe up and down to scroll through the list options, and tap to select.

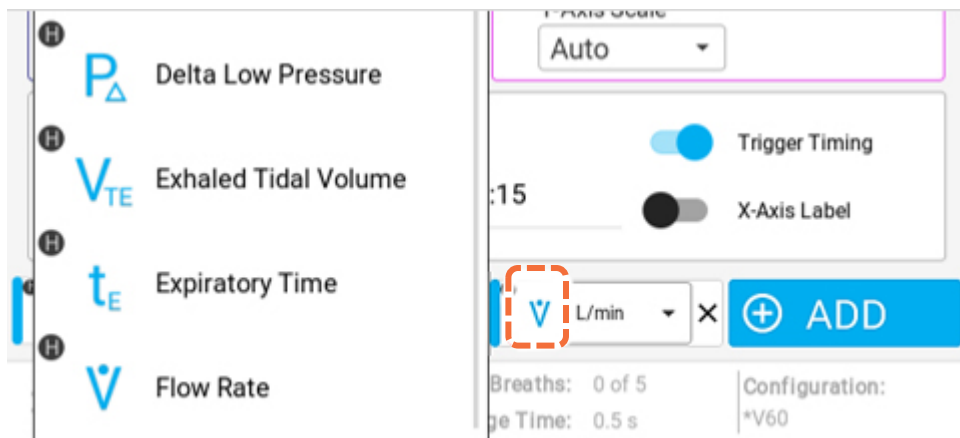

To change the units of measurement for a parameter, press on the currently selected units to access a drop-down list of available alternatives (see below right). Refer to the table [Available Units of Measurement](#) to see all the available units for each measurement.

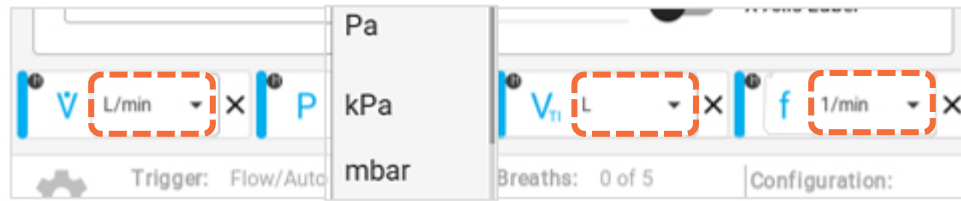

To reorder the selected real-time measurements, press and hold a measurement tile to be able to drag it left or right along the bottom of the display. The other tiles will adjust on the screen as the tile is being dragged, release the tile once the desired position has been reached.

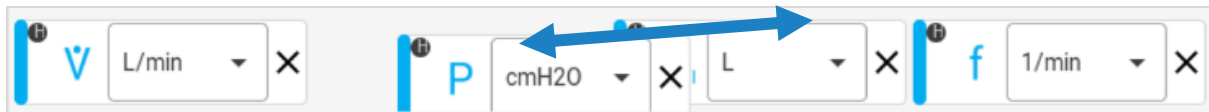

To remove a measurement from being displayed on the **Parameter** screen, press the **X** located next to the units for that measurement.



Press the orange **X** button in the right navigation bar at any time to disregard all changes and return to the **Parameter** screen.



Press the green ✓ checkmark button in the right navigation bar to save changes and return you to the **Parameter** screen.

---

## Zeroing and Calibration

### Zero Pressure Sensors

The Certifier™ Pro Flow Analyzer contains embedded low pressure and high pressure sensors. TSI® recommends zeroing these transducers before each pressure measurement to ensure the most accurate readings.

To zero the pressure sensors, perform the following steps:

1. Uncap or disconnect any pressure tubing from the low pressure and high pressure ports located on the front of the instrument in order to expose the sensors to the ambient air.

2. Press the zero icon located in the right navigation bar of the Certifier™ display (see below right).
3. Select the sensor(s) to be zeroed by checking their boxes and press the **Zero Selected** button, or press the **Zero All** button to select and zero all pressure sensors.

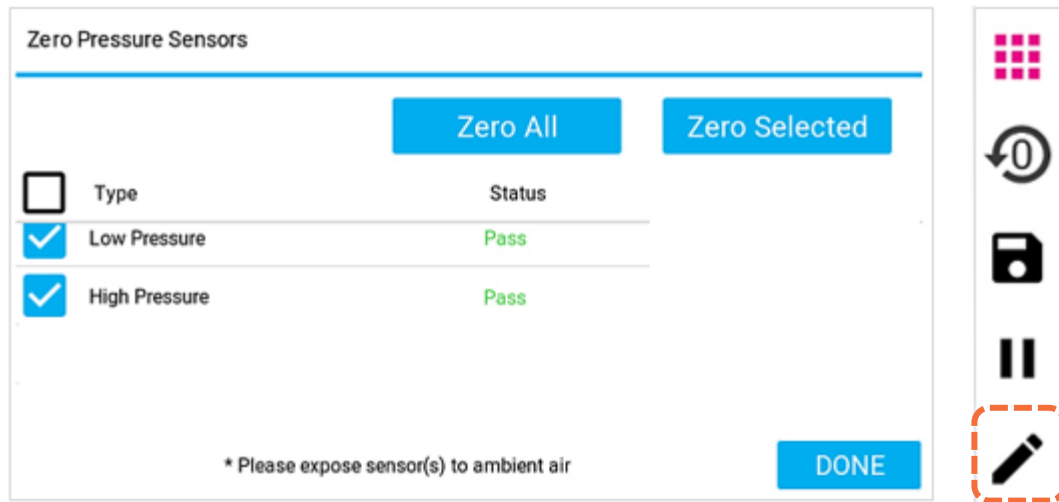

After zeroing, a status is displayed for each pressure sensor to indicate the result of the zero process. The pressure sensors can be zeroed more than once by you while in the **Zero Pressure Sensors** screen. Press the **DONE** button to return to the Certifier™ dashboard screen.

**NOTICE**

The barometric pressure sensor (used for absolute pressure measurements) **does not** require zeroing; and therefore, this sensor is not displayed in the **Zero Pressure Sensors** screen.

### Calibrate Oxygen Sensor

An oxygen sensor can be connected to the Certifier™ Pro Flow Analyzer to provide real-time oxygen concentration measurements. TSI® recommends the oxygen sensor be field calibrated on a daily basis as well as after replacing the oxygen sensor cell or after a change in altitude.

To field calibrate an oxygen sensor, perform the following steps:

1. Power up the Certifier™ Pro test system with the oxygen sensor connected to the inlet of the high flow channel, and allow one minute for the Certifier™ Flow Analyzer to warm up.
2. On the Certifier display, press the **Menu** icon and select the **Settings** option. From the **Settings** screen, select the **Oxygen Sensor** option.

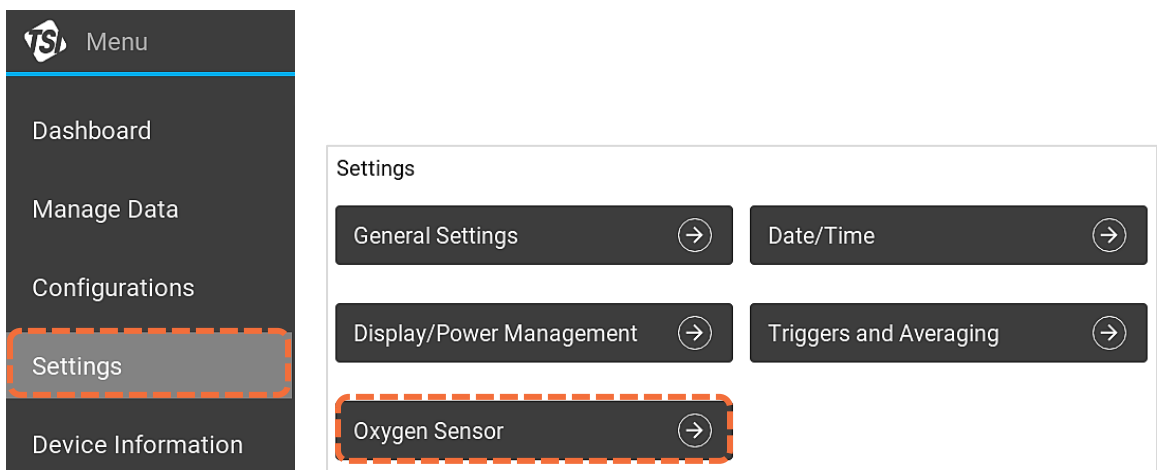

- In the **Oxygen Sensor** screen, the Certifier™ Flow Analyzer will display any connected oxygen sensors. Press the **Calibrate** button and follow the on-screen directions to complete the calibration process. *Note that either an “air only” or “air and 100% oxygen” calibration can be done.* The two point air and 100% oxygen calibration provides the best accuracy.

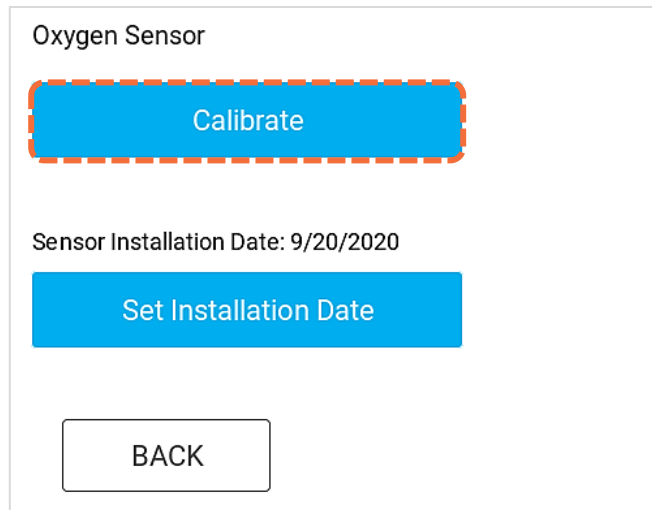

### Set Installation Date

You can input a date in order to keep an on-instrument record of the installation for the oxygen sensor. Press the **Set Installation Date** button, select a date in the calendar pop-up window, and Save.

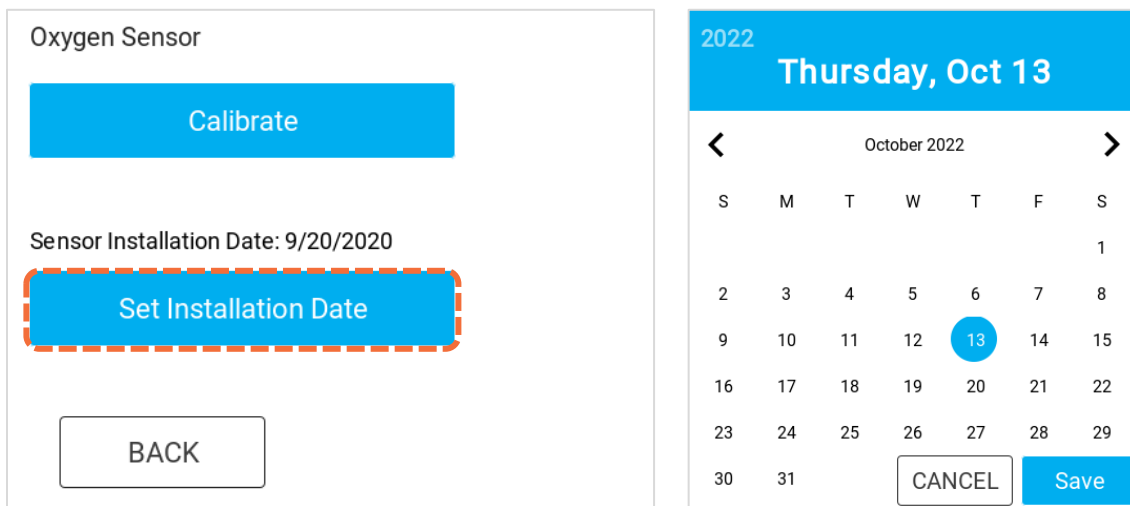

### NOTICE

The numeric value displayed during the stabilization process does not necessarily represent the actual oxygen concentration. This numeric stabilization value is there for you to determine if it is changing or not. Once the reading stops changing then it is time to advance to the next step in the oxygen sensor calibration process.

# Data Logging and Export

The Certifier™ Pro Flow Analyzer is capable of logging measurement data and capturing screenshots. Files are saved to the internal memory of the Certifier™ Flow Analyzer and can be exported through either of its two USB-A ports. Saved data is exported as .csv files and screenshots are exported as .png files.

## Data Acquisition

Press the save icon (disk image) in the right navigation bar to access the **Data Save Options** screen. Upon pressing the save icon, the Certifier™ Flow Analyzer will automatically pause the display from updating while you choose between taking a snapshot, continuous logging, or waveform logging.

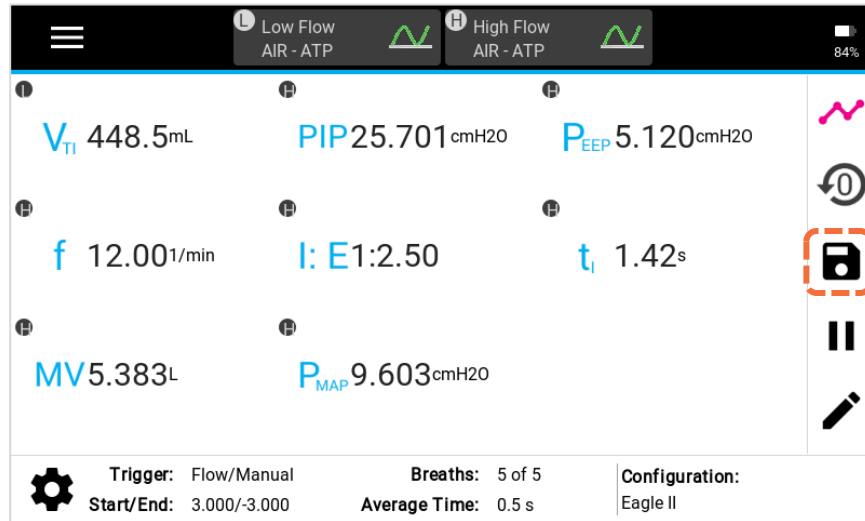

## Snapshot

The Snapshot feature saves a screenshot image as well as saves the data currently displayed on the screen, either from the **Parameter** screen or **Graph** screen. Upon executing a snapshot, the Certifier™ Flow Analyzer will create two files, an image file for the screen capture and a data file with a single data point.

With the **Snapshot** option selected, a name is generated for the file using the screen being saved on, either "Parameters" or "Graph", followed by the current date and time. You can save with this name or edit the **Name** field to input a custom name. You can input comments that will be attached to the saved file.

The screenshot shows the "Data Save Options" dialog box. It has a title bar "Data Save Options" and a subtitle "Saves screenshot image and data currently displayed". On the left, there are three radio buttons under the heading "Save Data As": "Snapshot" (selected), "Continuous", and "Waveform". On the right, there is a "Name:" field with the text "Parameters-2022-02-23T11-18-25" and a "Comments:" field which is empty. At the bottom right, there are two buttons: "CANCEL" and "SAVE".

## NOTICE

After pressing the **SAVE** button, the Certifier™ Flow Analyzer will return to the previous screen with the display still paused. Press the **Play** button (triangle icon) in the right navigation bar to resume updating the display.



Pressing the **CANCEL** button from the **Data Save** screen will return you to the previous screen and automatically resume updating the display.



### Continuous Logging

Continuous logging initiated from the **Parameter** screen will save data for the measurements currently selected on screen. Initiated from the **Graph** screen, Continuous will save data for the plotted graph measurements. The sampling rate at which data is collected can be set from 1 second to 10 minutes. The collection time can be set from 15 seconds to up to 5 days (120 hours) of continuous logging.

With the **Continuous** option selected in the **Data Save** screen, a name is generated for the file using “**Continuous**” followed by the current date and time. You can save with this name or edit the Name field to input a custom name. You can input comments that will be attached to the logged file. Press **START** to initiate logging, press **CANCEL** to disregard saving data and return to the previous screen.

Data Save Options

---

Save Data As

Snapshot

Continuous

Waveform

Saves data for measurements displayed on the Parameter screen

Sampling Rate      Collection Time

00:00:01      00:00:01:00

Name:

Comments:



## Waveform Logging

Waveform logging is used to record raw sensor data with high resolution. Waveform logs include data for flow rate, low pressure, high pressure, absolute pressure, temperature, and oxygen concentration (if connected) regardless of the screen from which logging was initiated. The sampling rate for waveform logging is fixed at 1 ms (1000 Hz). You can set the collection time from 15 to 60 seconds.

With the **Waveform** option selected in the **Data Save** screen, a name is generated for the file using "**Waveform**" followed by the current date and time. You can save with this name or edit the **Name** field to input a custom name. You can input comments that will be attached to the logged file. Press **START** to initiate logging, press **CANCEL** to disregard saving data and return to the previous screen.

Data Save Options

Save Data As

Snapshot

Continuous

Waveform

Saves raw sensor data at 1000 Hz

Sampling Rate: 1 ms

Collection Time: 00:00:15

Name: Waveform-2022-02-23T11-18-25

Comments:

CANCEL START

## Cancel/Stop an Active Log

The Certifier™ display is disabled while actively collecting data from a **Continuous** or **Waveform** log, and you can only toggle between the **Parameter** and **Graph** screens during this time. The collection time remaining is shown counting down on the left side of the header bar (circled in green below). During active logging the right navigation bar will populate buttons for you to cancel or stop logging (circled below in red). Once logging has completed, the Certifier create a log file and the display will become re-enabled.

To cancel the active data log, press the top **X** button in the right navigation bar. Cancelling will end the active log and disregard any data saved up to that point. To stop the active data log, press the bottom red square button in the right navigation bar. Stopping will end the active log and create a log file with the data saved up to that point.

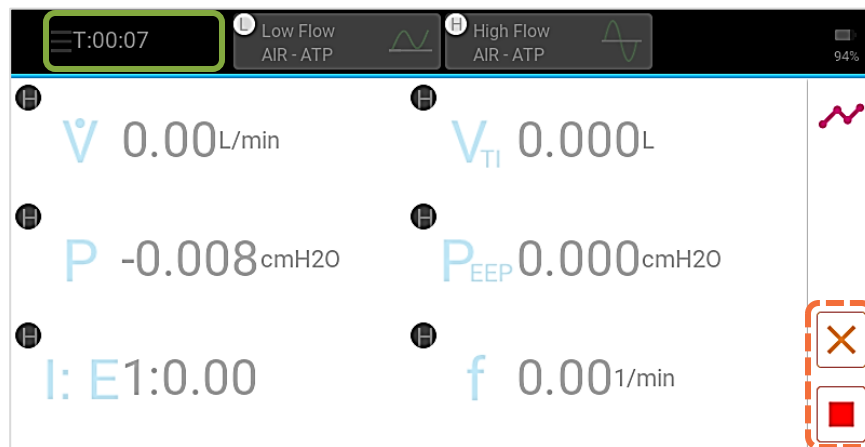

## Managing Data

Saved screenshots and data log files are stored in the internal memory of the Certifier™ Pro Flow Analyzer and can be viewed from the **Manage Data** screen. Access the **Manage Data** screen by pressing the **Menu** and selecting the **Manage Data** menu option. From this screen you can preview, export, or delete screenshots and saved files.

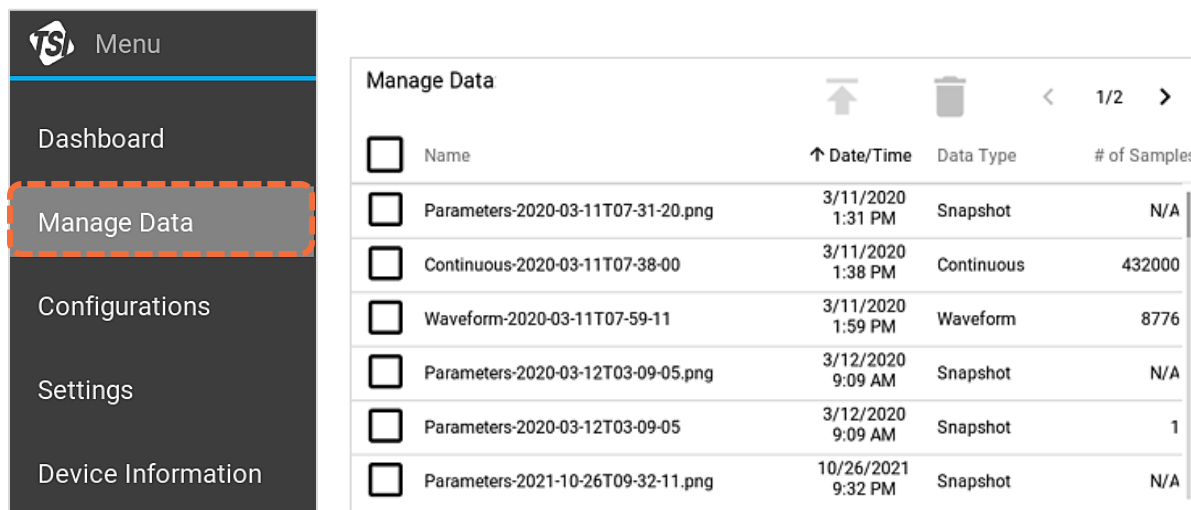

The **Manage Data** screen lists all the individual saved data files and screenshots available to the user. The **Data Type** column corresponds to the Certifier™ logging options and files are labeled as either **Snapshot**, **Continuous**, **Waveform**, or **Graph**. The **# of Samples** column denotes the number of data points collected for each file and equals the sampling rate multiplied by the collection time.

Press on the **Name** heading or **Date/Time** heading to order the list of saved files by that column value in either ascending or descending order. Swipe up and down on the screen to scroll through the list of files. If there is more than one page of saved files, press the arrows in the upper right of the screen to tab through the different pages.

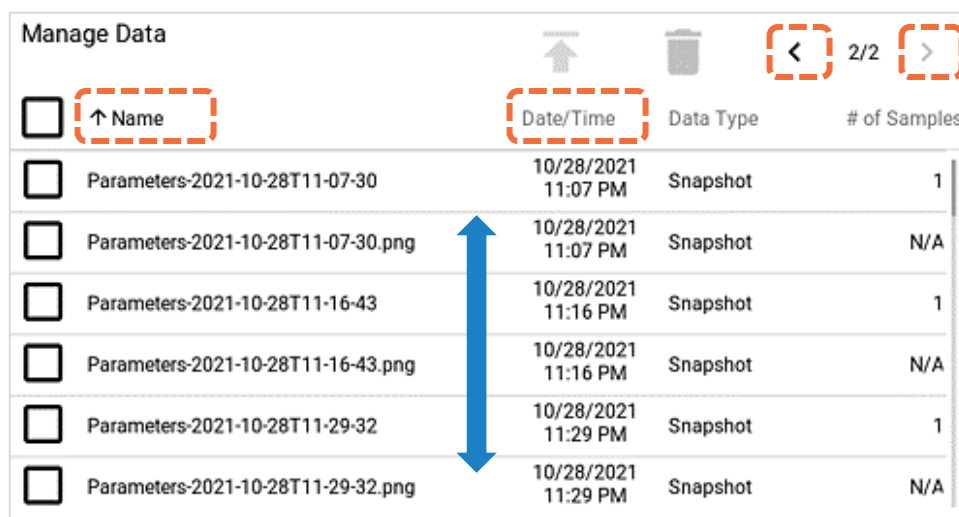

## Preview Saved Files

You can preview screenshots and data logs from the Certifier™ Pro display prior to exporting. To do this, press anywhere on the row of the file you want to view.

Manage Data				
<input type="checkbox"/>	Name	Date/Time	Data Type	# of Samples
<input type="checkbox"/>	Continuous-2022-02-24T02-25-32	2/24/2022 2:25 AM	Continuous	60
<input type="checkbox"/>	Continuous-2022-02-24T02-14-25	2/24/2022 2:14 AM	Continuous	32
<input type="checkbox"/>	Waveform-2022-02-24T01-57-38	2/24/2022 1:58 AM	Waveform	15000
<input type="checkbox"/>	Continuous-2022-02-24T01-53-49	2/24/2022 1:53 AM	Continuous	15
<input type="checkbox"/>	Continuous-2022-02-24T01-41-09	2/24/2022 1:46 AM	Continuous	15
<input type="checkbox"/>	Graph-2022-02-24T01-30-54	2/24/2022 1:30 AM	Graph	227

In the **File Preview** screen, you can preview screen captures or logged data in graph form. For data log files, the preview screen displays the number of data points collected, log start time, total logging time, sampling rate, the active configuration, comments, and the module from which the data came from. Screen capture file previews include the file name, date and time of capture, and any comments.

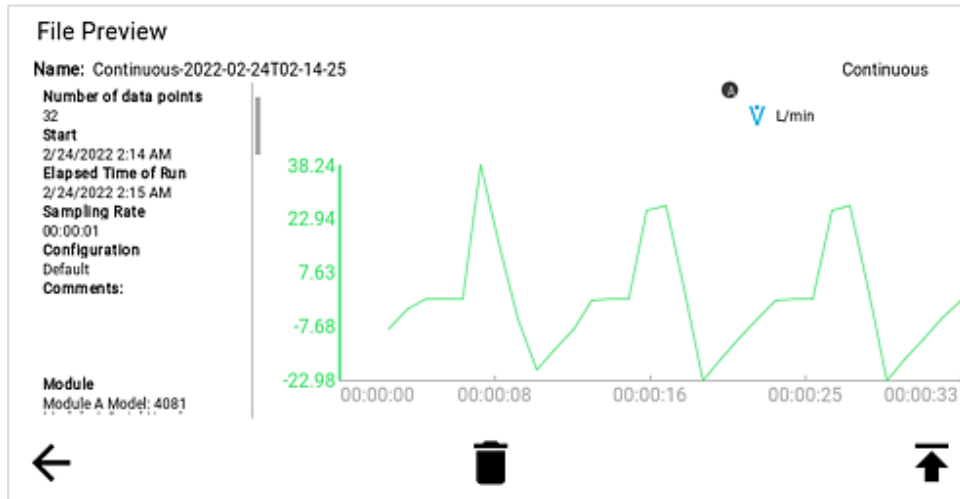

Saved files can also be deleted or exported from within the **File Preview** screen using the buttons on the bottom of the screen. Press the left arrow icon to return to the **Manage Data** screen. Press the garbage can icon to delete the currently previewed file, press the up arrow icon to export the currently previewed file.

**NOTICE**

A USB flash drive **must** be inserted into the Certifier™ Pro Flow Analyzer to export a saved file.



Press on the image in the **File Preview** screen to increase its size for easier viewing. Press on the image again to return the expanded image to its original size.

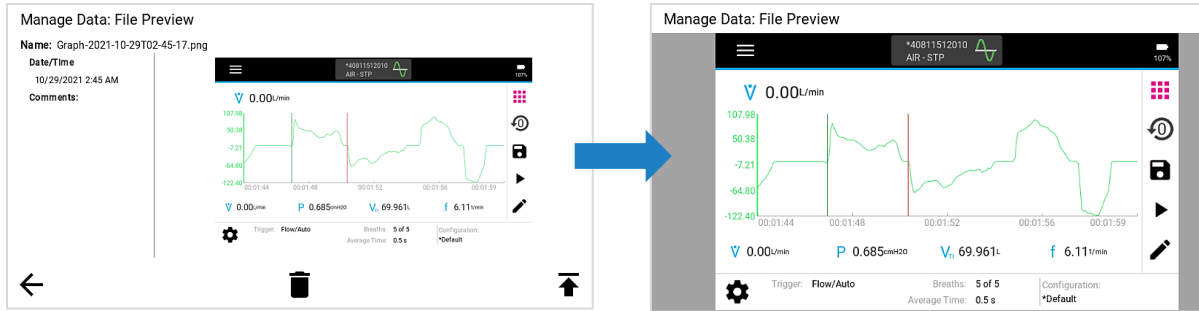

## Delete Saved Files

In the **Manage Data** screen, use the check boxes to select one file or multiple files. Press a check box to select and press again to deselect. Click the check box in the heading to select all files. Press the delete button (garbage can icon) to delete selected files; the Certifier™ Pro Flow Analyzer will ask to confirm the deletion.

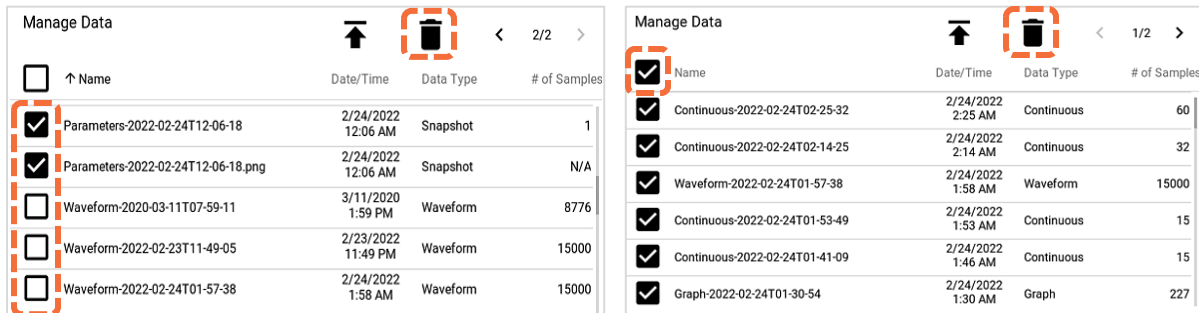

## Exporting Data

Saved screenshots and data log files can be exported through either of the two USB-A ports located on the top side of the Certifier™ Pro Model 4089 Interface Module. To export one or more saved files, insert a USB flash drive into the Certifier™ Flow Analyzer and navigate to the Manage Data screen. Press on an individual file row in the Manage Data screen to preview the file on screen prior to exporting through USB.

Use the check boxes to select one file or multiple files. Press a check box to select, and press the box again to deselect. Click the check box in the heading to select all files. Press the export button (up arrow icon) to export selected files.

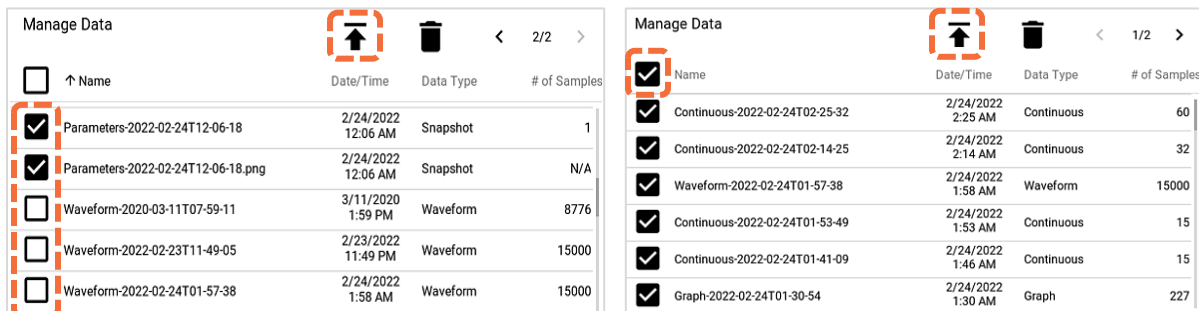

While actively exporting files, a loading icon will appear and the export progress is shown in the bottom screen bar. The Certifier™ Flow Analyzer will provide notification when the export has completed.

<input type="checkbox"/>	Continuous-2022-02-24T02-14-25		2/24/2022 2:14 AM	Continuous	32
<input checked="" type="checkbox"/>	Waveform-2022-02-24T01-57-38		2/24/2022 1:58 AM	Waveform	15000
<input type="checkbox"/>	Continuous-2022-02-24T01-53-49		2/24/2022 1:53 AM	Continuous	15
<input type="checkbox"/>			2/24/2022		

Waveform-2022-02-24T01-57-38 exported record 12000 of 15000

Snapshots are exported as .png image files and data is exported as .csv files. The delimiter for data export can be set as comma, pipe, semicolon, or tab delimited. Select the **Export Delimiter** in the **General Settings** page of the **Settings** menu option.

### Viewing Exported Data

Exported .csv files can be opened and viewed within Excel® or an equivalent spreadsheet program. See [Appendix A](#) for examples of exported data formats for Snapshots, Continuous, and Waveform data logs.

NOTICE

The cell in the “Time” column will need to be reformatted in order to display properly. To format:

1. Select all the data in the column.
2. Select **“Format Cells.”**
3. Choose the **Custom** category.
4. Select **h:mm:ss** as the Type.

To include millisecond data as part of the Time column cells, enter “.000” after the hh:mm:ss in the Type field.

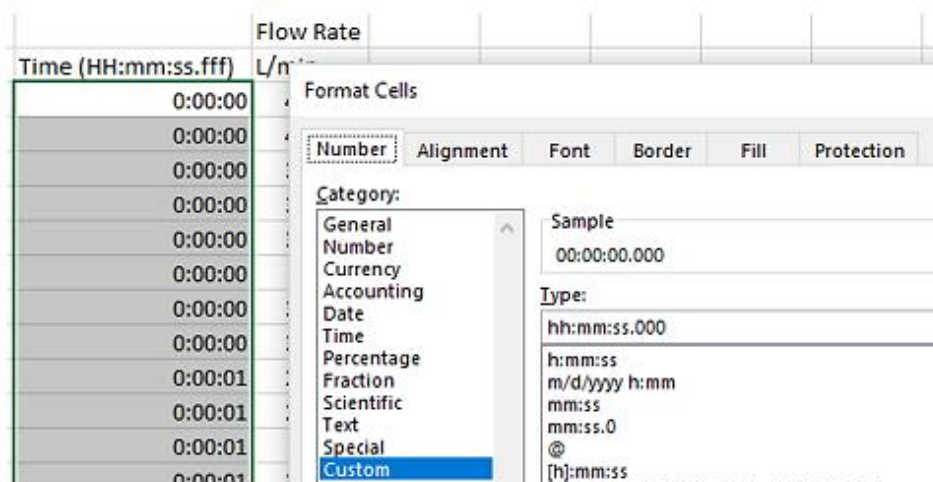

# Device Settings

Access the device settings by choosing the **Settings** option from the **Menu** drop-down. From this screen, you can select which functional settings to view and adjust.

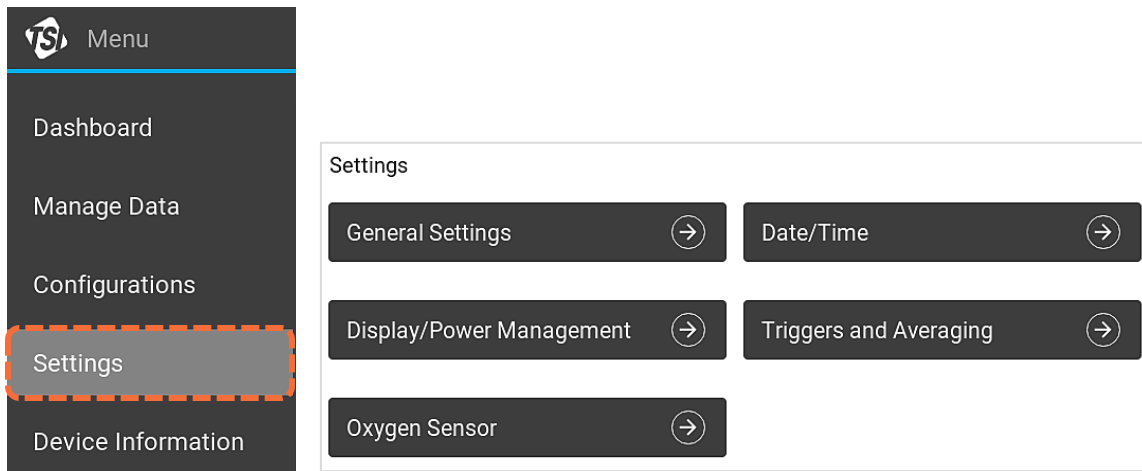

## General Settings

In this screen you can set the **Export Delimiter** and **Decimal** format for the Certifier™ instrument. The export delimiter is used to specify how exported data is separated on the .csv file. The export delimiter can be set to comma, pipe, semicolon, or tab. The decimal specifies whether a period or a comma is used for the decimal mark. Press on the fields to edit their values. The language cannot be changed.

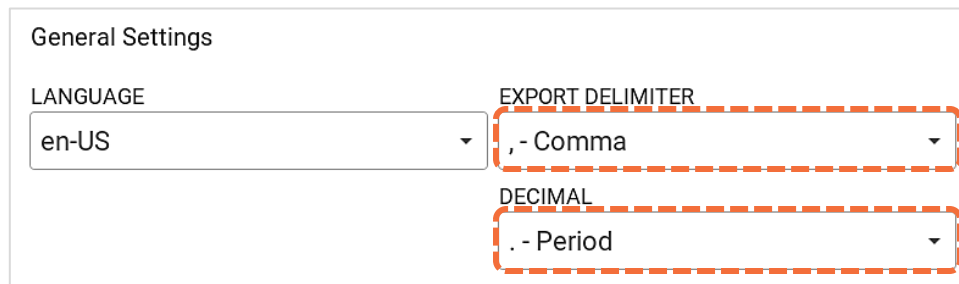

## Date/Time

You can set the time, date, and date format for the Certifier™ instrument. Press on the fields to edit their values. Press the toggle to switch to 24-hour format, press again to return to 12-hour format. Select between **AM** and **PM** time.

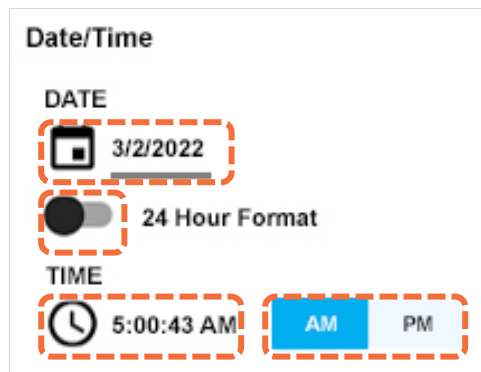

## Display/Power Management

You can adjust the display brightness to your preferred brightness including dimming the brightness in order to conserve power. Press on the gray scroll bar or drag the blue circle indicator to set the brightness level.

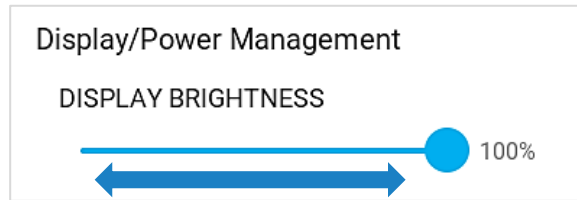

## Flow Channel Power Toggles

The default mode for the Certifier™ Pro Flow Analyzer is to always power on both flow channels. In order to reduce power consumption and extend battery operation, you have the option to turn either flow channel off. The high flow channel controls flow or pressure triggers as the default. Power off the high flow channel in order for the low flow channel to control triggering for the Certifier™ Pro instrument. To turn off a flow channel, press on the corresponding toggle switch to the power off.

### NOTICE

The application will reboot after pressing **Save** in order to apply the change.

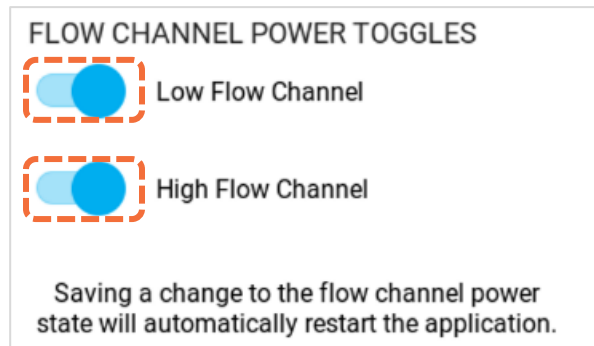

## Triggers and Averaging

You can navigate to the triggers and averaging settings through the menu screen as an alternative to accessing these settings from the dashboard screens. Refer to the [Breath Triggers](#) and [Averaging](#) sections for detailed instructions.

## Oxygen Sensor

In the **Oxygen Sensor** screen is where you can field calibrate the integrated oxygen sensor. Refer to the section [Calibrate Oxygen Sensor](#) for oxygen calibration instructions.

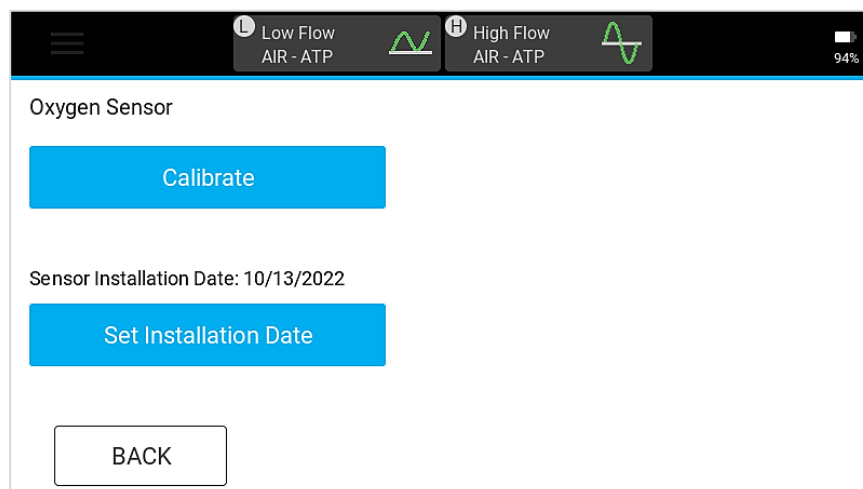

# Device Information

The device information screen displays information about the Certifier™ Pro instrument. Access this screen by selecting the **Device Information** option from the menu drop-down.

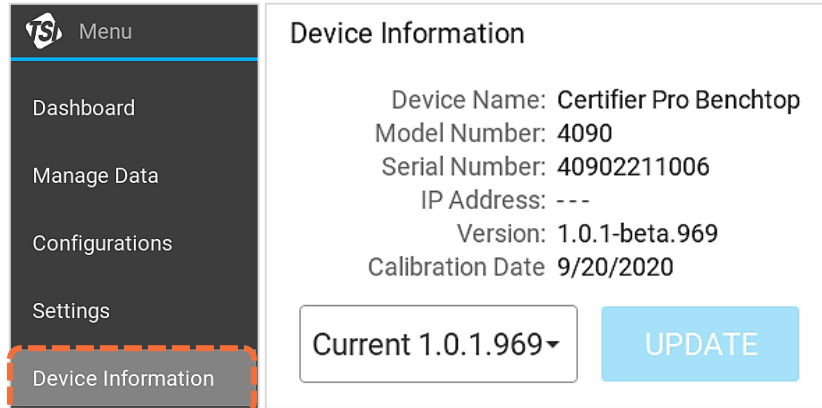

The Version field lists the firmware version currently implemented for the Certifier™ Pro Flow Analyzer. The Calibration Date field is set by TSI® during calibration service as part of the sensor adjustment process.

## Update Firmware

The firmware version for the Certifier™ Pro Model 4090 Flow Analyzer is displayed in the device information screen. You can perform field firmware updates to the instrument.

To update firmware, download the latest firmware version from [tsi.com](http://tsi.com) and save the file to a USB mass storage drive. Insert the USB drive into either of the USB-A ports on the back of the Certifier Pro instrument and press the **UPDATE** button on the screen.

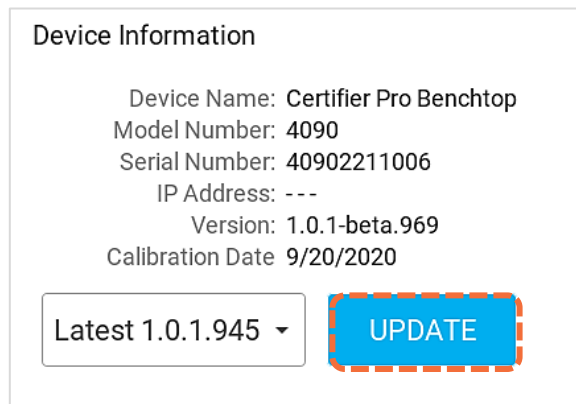



## CHAPTER 5

# Troubleshooting

The table below lists the symptoms, possible causes, and recommended corrective actions for problems that may be encountered while operating the Certifier™ Pro system. If the symptom is not listed or if none of the recommended corrective actions solve the problem, contact technical support at [technical.services@tsi.com](mailto:technical.services@tsi.com) or customer support at 800-680-1220 or 651-490-2860 for assistance.

Symptom	Possible Cause	Corrective Action
Certifier™ Pro Flow Analyzer will not turn on, or turns on and off.	Batteries depleted or not installed.	Connect AC adapter or install charged batteries.
Measurements not changing or graph is not updating.	The display is paused.	Press the play icon in the right navigation bar.
“OOR” is shown on display.	Measurement is out of range.	Check range for displayed measurement and only make measurements within that range.
Flow rate does not read zero when no gas flowing, especially when set to N <sub>2</sub> O or CO <sub>2</sub> .	Flow analyzer was not purged with gas type selected.	Purge flow analyzer with the gas displayed or change the gas type on the Certifier™ Flow Analyzer to the desired gas.
Pressure trigger gives erroneous results.	Pressure signal supplied to the flow analyzer is not correct.	Change source of pressure signal. Pressure triggers are optimized for use with high-frequency ventilators.
Volume, minute volume, peak flow, peak pressure, PEEP, frequency, or I:E ratio measurements are not updated or incorrect.	Less than two consecutive full breath have been supplied to the flow analyzer or flow is not supplied as breath waveform.	Wait for at least two consecutive full breaths to be supplied to the flow analyzer.
	Auto-trigger is not optimized for the current waveform.	Ensure that flow is supplied as a breathing waveform. Manually set the flow trigger levels.
	Airway restrictor is causing flow disturbance next to the flow analyzer.	Use TSI® airway pressure fitting which contains a screen between the flow analyzer and test lung.
	Flow condition is causing oscillations in the waveform.	Minimize the length of tubing between the test lung and the airway pressure fitting.
I:E ratio or I time readings do not appear correct.	It's possible the inspiratory pause function is turned on inside the ventilator.	Display the I time, T <sub>I+P</sub> , and I:E <sub>IP</sub> ratio when the inspiratory pause is activated on the ventilator. Or turn off the inspiratory pause feature on the ventilator.
Cannot zero low pressure or high pressure sensors.	Sensor is connected to a pressure source.	Disconnect the pressure tubing from the flow analyzer and then re-zero the pressure sensors.
Cannot zero barometric pressure sensor.	Barometric pressure sensor does not require a zero calibration.	Resume normal system operation.

Symptom	Possible Cause	Corrective Action
Oxygen sensor calibration fails.	21% oxygen and/or 100% oxygen not supplied for calibration. Oxygen sensor is expired. Non-steady flow or tidal flows used.	Verify that calibration gases are 21% and 100% O <sub>2</sub> and repeat calibration. Replace oxygen sensor. Use constant flow rates to supply calibration gas.
Unable to export configurations or log files to removable USB drive.	USB drive is not recognized by the Certifier Flow Analyzer.	Reformat the USB drive to FAT32 format. Reformat even if the drive shows FAT32 already.
	USB drive does not contain enough free space available.	Delete files on USB drive to create more available space.
Battery is not powering the instrument long enough.	Running both flow channels on the instruments consumes additional power.	Turn off an unused flow channel in the Display/Power Management screen to conserve power.
Battery will not charge with the instrument plugged in to power.	Battery has discharged beyond minimum charge level.	Unplug and plug power adapter back in and charge for 10 minutes. Repeat until normal charging is observed.

## CHAPTER 6

# Maintenance

---

### Recharging the Battery

The fastest charging method is to charge the internal batteries with the Certifier™ Pro Flow Analyzer Test System turned off. With new batteries and the Certifier™ instrument turned off, the charging time to go from empty to a full charge is approximately four hours. When connected to AC power, the Certifier™ Pro Flow Analyzer will charge the internal batteries during operation; however, the time to full charge will be extended. The batteries cannot be charged externally from the Certifier Flow Analyzer.

The interface module can be powered by internal Lithium-Ion battery or an AC power adapter can be used. If the AC adapter is delivering power to the Certifier Interface Module and the battery is installed, a lightning bolt symbol will be displayed in the battery icon to indicate active battery charging.

---

### Replacing the Battery

The Certifier™ Pro Flow Analyzer comes with the battery pre-installed into the instrument. The battery will function for four or more years with normal operation of the Certifier Pro test system. To remove or install a battery, a Phillips®-head screwdriver is required.

To remove a battery from the Certifier Pro Flow Analyzer:

- Turn the Certifier instrument off and disconnect any cables.
- Remove the cover from the bottom of the Certifier case by unscrewing the four (4) screws and lifting by the knob.
- Disconnect the battery pack by unplugging the pigtail connector from the Certifier Flow Analyzer.
- Remove the battery pack by unscrewing the one (1) screw and lifting the retainer plate.



To install a battery into the Certifier™ Pro Flow Analyzer:

- Turn the Certifier™ instrument off and disconnect any cables.
- Remove the back plate and plug the battery pigtail connector into the Certifier™ Pro Flow Analyzer.
- Lift the retainer plate and insert the battery pack underneath, secure plate with one (1) screw.
- Attach the back cover by aligning the holes and screwing in the four (4) screws.



## Battery Calibration

After a new or different battery is field installed into the Certifier Pro Flow Analyzer, the battery should be calibrated to provide the most accurate power indicator readings.

To self-calibrate the battery:

- Connect the power adapter to the Certifier Pro instrument.
- Charge the instrument up to a full battery charge (100%).
- Unplug the Certifier Flow Analyzer from power and turn the instrument on.
- Run the Certifier instrument on battery power to a fully discharged state (unit will automatically shut down).
- Connect the power adapter to the Certifier Pro instrument and charge/use as normal.

---

## Replacing the Oxygen Sensor

The oxygen sensor will function for one or more years of normal operation if use begins before the expiration date. Replace the oxygen sensor after every year or two of normal use, if the sensor cannot be calibrated, or if sensor readings are erratic. Refer to the [Calibrate Oxygen Sensor](#) section for detailed sensor calibration instructions.

To replace the oxygen sensor cell for the Certifier™ Pro Flow Analyzer:

- Turn the Certifier™ instrument off and disconnect any cables.
- Remove the cover from the bottom of the Certifier™ case by unscrewing the four (4) screws and lifting by the knob.
- Remove the oxygen sensor by retracting it from the Certifier instrument and screwing the cell.
- Connect an oxygen sensor by screwing in the cell and pushing it back into the Certifier instrument.
- Attach the bottom cover by aligning the holes and screwing in the four (4) screws.



---

## Cleaning the Flow Analyzer

The table below summarizes TSI® Incorporated's recommended methods for cleaning the primary components of the Certifier™ Pro test system.

Component	Cleaning
<ul style="list-style-type: none"><li>• Certifier Pro instrument</li><li>• Carrying cases</li><li>• Oxygen sensor</li></ul>	Clean exterior as required with a clean cloth and isopropyl alcohol, hydrogen peroxide (3%), or ammonia (15%). Remove dust, particles, and fibers from the flow module sensors with clean, dry compressed air.
<ul style="list-style-type: none"><li>• Tee</li><li>• Flow adapters</li></ul>	Steam autoclave after contact with any non-sterile breathing circuit components, and discard if any damage is visible.
<ul style="list-style-type: none"><li>• Single use filters (high and low flow modules)</li></ul>	Discard after contact with any non-sterile breathing circuit components or if damage is visible.



### WARNING

**DO NOT** submerge any Certifier™ Flow Analyzer components and **NEVER** run liquids through the flow modules. **NEVER** touch the flow sensor mounted inside the flow module as it will break upon contact.

---

## Factory Calibration (recommended annually)

To maintain a high degree of confidence in the measurements made by the Certifier™ Pro Flow Analyzer, TSI® recommends that the instrument be returned to TSI® Incorporated for re-calibration every 12 months following initial factory calibration.

All re-calibrated instruments are returned from TSI® with a certificate of calibration and a summary of performance before and after the calibration. A calibration consists of pressure calibrations over the full range of pressures and flow calibration over the full range of flows.

---

## Return Procedure

Follow these steps to return a Certifier™ Pro Flow Analyzer to a TSI® service center for calibration and/or repair service:

- Obtain a service request number by completing a “Service Request” form online at [tsi.com/service](http://tsi.com/service), or contact one of the TSI® offices listed below to make the arrangements.
- Register an account with TSI® or create the service request as a guest.
- The Service Request form will provide instructions and the TSI address for returning the equipment.
- Package the Certifier™ Pro Flow Analyzer carefully to avoid damage during shipping. *Please note that it is not necessary to return accessories for calibration service.*

<p><b>TSI Incorporated</b> 500 Cardigan Road Shoreview, MN 55126 USA <b>Phone:</b> +1-800-680-1220 (USA) <b>E-mail:</b> <a href="mailto:technical.services@tsi.com">technical.services@tsi.com</a></p>	<p><b>TSI Instruments Singapore Pte Ltd</b> 150 Kampong Ampat #05-05 KA Centre SINGAPORE 368324 <b>Telephone:</b> +65 6595-6388 <b>Fax:</b> +65 6595-6399 <b>E-mail:</b> <a href="mailto:tsi-singapore@tsi.com">tsi-singapore@tsi.com</a></p>
<p><b>TSI GmbH</b> Neuköllner Strasse 4 52068 Aachen GERMANY <b>Telephone:</b> +49 241-52303-0 <b>E-mail:</b> <a href="mailto:tsigmbh@tsi.com">tsigmbh@tsi.com</a></p>	<p><b>TSI Instrument (Beijing) Co., Ltd.</b> Unit 1201, Pan-Pacific Plaza, No.12 A, Zhongguancun South Avenue Haidian District, Beijing CHINA 100081 <b>Telephone:</b> +86-10-8219 7688 <b>Fax:</b> +86-10-8219 7699 <b>E-mail:</b> <a href="mailto:tsibeijing@tsi.com">tsibeijing@tsi.com</a></p>
<p><b>TSI Instruments Ltd.</b> Stirling Road Cressex Business Park High Wycombe, Buckinghamshire HP12 3ST UNITED KINGDOM <b>Telephone:</b> +44 (0) 149 4 459200 <b>E-mail:</b> <a href="mailto:tsiuk@tsi.com">tsiuk@tsi.com</a></p>	

# CHAPTER 7

## Specifications

Specifications are subject to change without notice.

---

### Physical

Dimensions	Instrument: 11 x 8.3 x 4.5 inches
Flow connectors	High Flow Channel: <ul style="list-style-type: none"><li>• Inlet: 22 mm female ISO taper</li><li>• Outlet: 22 mm male ISO taper</li></ul> Low Flow Channel: <ul style="list-style-type: none"><li>• Inlet: 1/4 inch tube</li><li>• Outlet: 3/8 inch tube</li></ul>
Weight	Instrument: 5.5 pounds (2.5 kg)

---

### Environmental

Temperature	Operating: 5 to 40 °C, Humidity: -20 to 35 °C dew point, non-condensing Storage: -40 to 70 °C, Humidity: -40 to 35 °C dew point, non-condensing
Atmospheric Pressure	Operating: 57.1 to 106 kPa Storage: 15000 meters
Conditions	Indoor Use Operating Altitude of -150 to 4000 m Pollution degree I or II

---

### Power

Battery Life	Up to 6 hours under typical usage (with both channels powered)
Battery Type	Lithium-Ion, proprietary form factor, 7.2 V 6.4 Ahr
AC Adapter	12 VDC, 3A minimum

---

### Compliance

The Certifier™ Pro Test System includes the following marks, compliance, and FCC statements:

- CE mark, UKCA mark, ETL Listed mark, RCM mark, and RoHS compliance.
- Per FCC 15.19(a)(3) and (a)(4) This device complies with part 15 of the FCC Rules. Operation is subject to the following two conditions: (1) This device may not cause harmful interference, and (2) this device must accept any interference received, including interference that may cause undesired operation.
- Per FCC 15.21, The user manual or instruction manual for an intentional or unintentional radiator shall caution the user that changes or modifications not expressly approved by the party responsible for compliance could void the user's authority to operate the equipment.

# Measurements

See additional notes listed at the end of the specifications.

Measurement <sup>1</sup>	High Flow Channel <sup>2</sup>	Low Flow Channel <sup>3</sup>
<b>Flows</b>	$\dot{V}$ , $\dot{V}_{PEAK}$ , $\dot{V}_{MIN}$	
Range	-200 to +300 SLPM for air, oxygen, and nitrogen -40 to +40 SLPM for carbon dioxide 0 to 300 SLPM for air/oxygen mixes	0.01 to 20 SLPM for air, oxygen, nitrogen, carbon dioxide, and nitrous oxide
Accuracy <sup>4</sup>	<b>Air, oxygen:</b> ±1.75% of reading and ±0.05 SLPM <b>Nitrogen, carbon dioxide:</b> ±3% of reading and ±0.05 SLPM <b>Air/Oxygen mixtures:</b> ±3% of reading and ± 0.075 SLPM	<b>Air and oxygen:</b> ±1.75% of reading and ±0.008 SLPM <b>Nitrogen, carbon dioxide:</b> ±3% of reading and ±0.01 SLPM <b>Nitrous oxide:</b> ±3% of reading and ± 0.025 SLPM
<b>Inspiratory Volumes</b>	$V_{TI}$	
Range	0.01 to 10 liters	0.01 to 10 liters
Accuracy <sup>4</sup>	<b>Air, O<sub>2</sub>:</b> ±2% of reading and 0.02 liters <b>Air/O<sub>2</sub> mix, N<sub>2</sub>, CO<sub>2</sub>:</b> ±3% of reading and 0.02 liters	<b>Air, O<sub>2</sub>:</b> ±2% of reading and 0.005 liters <b>N<sub>2</sub>O, N<sub>2</sub>, CO<sub>2</sub>:</b> ±3% of reading and 0.005 liters
<b>Expiratory Volumes</b>	$V_{TE}$	
Range	0.01 to 10 liters	Not available
Accuracy <sup>4</sup>	<b>Air, O<sub>2</sub>:</b> ±2.5% of reading and 0.02 liters <b>Air/O<sub>2</sub> mix, N<sub>2</sub>, CO<sub>2</sub>:</b> ±3% of reading and 0.04 liters	Not available
<b>Minute Volume</b>	MV	
Range	0.01 to 100 liters	0.01 to 100 liters
Accuracy <sup>4</sup>	±3% of reading and 0.02 liters	±3% of reading and 0.005 liters
<b>Times</b>	$t_I$ $t_{IP}$ $t_{I+P}$ $t_E$ $t_R$	
Range	0.04 to 30 seconds	Not available
Accuracy	2% of reading or 0.01 second, whichever is greater	Not available
<b>I:E Ratios</b>	I:E I:E <sub>IP</sub>	
Range	1:100 to 100:1	Not available
Accuracy	±4% of reading	Not available
<b>Respiratory Rate</b>	f	
Range	1 to 1500 breaths per minute	Not available
Accuracy	±2% of reading or 0.1 BPM	Not available
<b>Low Pressures</b>	P P <sub>IP</sub> P <sub>E<sub>EP</sub></sub> P <sub>MAP</sub> P <sub>MIN</sub> P <sub>Δ</sub> P <sub>PLAT</sub>	
Range	-25 to +150 cm H <sub>2</sub> O	Not available
Accuracy	±0.5% of reading or ±0.15 cm H <sub>2</sub> O, whichever is greater	Not available



Measurement <sup>1</sup>	High Flow Channel <sup>2</sup>	Low Flow Channel <sup>3</sup>
<b>Leak Rate</b>	LR	
Range	±30 cmH <sub>2</sub> O/s	Not available
Accuracy	±0.5% of reading or ±0.2 cmH <sub>2</sub> O/s, whichever is greater	Not available
<b>High Pressure</b>	P <sub>High</sub>	
Range	-10 to 150.0 psig	Not available
Accuracy	±1% of reading or 0.1 psi, whichever is greater	Not available
<b>Absolute Pressure</b>	P <sub>ABS</sub>	
Range	50 to 200 kPa	50 to 200 kPa
Accuracy	±0.7% kPa	±0.7% kPa
<b>Static Compliance</b>	C <sub>Stat</sub>	
Range <sup>5</sup>	0.01 to 1000 cmH <sub>2</sub> O/ml	Not available
Accuracy	3% or 1 cmH <sub>2</sub> O/ml, whichever is greater	Not available
<b>Oxygen Concentration</b>	O <sub>2</sub>	
Range	21 to 100%	Not available
Accuracy	2% of reading	Not available
<b>Temperature</b>	T	
Range	5 to 40 °C	5 to 40 °C
Accuracy <sup>6</sup>	±1 °C at flow rates greater than 2 liters/min	See note 6 below

**NOTES:**

- 1 Standard conditions are defined as 21.1 °C (70 °F) and 101.3 kPa (14.7 psia). Flow and volume accuracy are applicable at these standard conditions. SLPM = standard liters per minute.
- 2 For the high flow channel, the temperature of the gas and the ambient air must be within ±10 °C (±18 °F) of each other and the gas must be less than 30% relative humidity at 21.1 °C (70 °F).
- 3 For the low flow channel, the temperature of the gas and the ambient air must be within ±5 °C (±9 °F) of each other and the gas must be less than 30% relative humidity at 21.1 °C (70 °F).
- 4 Flow and volume accuracies are stated at 21.1 °C (70 °F), 101.3 kPa (14.7 psia), and ≤ 30% RH.
  - Add an additional ±0.075% of reading per 1 °C (1.8 °F) away from 21.1 °C (70 °F).
  - Add an additional ±0.022% of reading per 1.03 kPa (0.15 psia) below 101.3 kPa (14.7 psia).
  - Add an additional ±0.07% of reading per 1% relative humidity above 30% relative humidity.
- 5 Must develop at least 7 cmH<sub>2</sub>O of pressure to obtain a valid static compliance measurement.
- 6 The temperature reading displayed from the low flow channel is not calibrated a measurement and should be used for reference only.

# Certifier™ Pro Flow Analyzer Pressure Drop

## Low Flow Channel

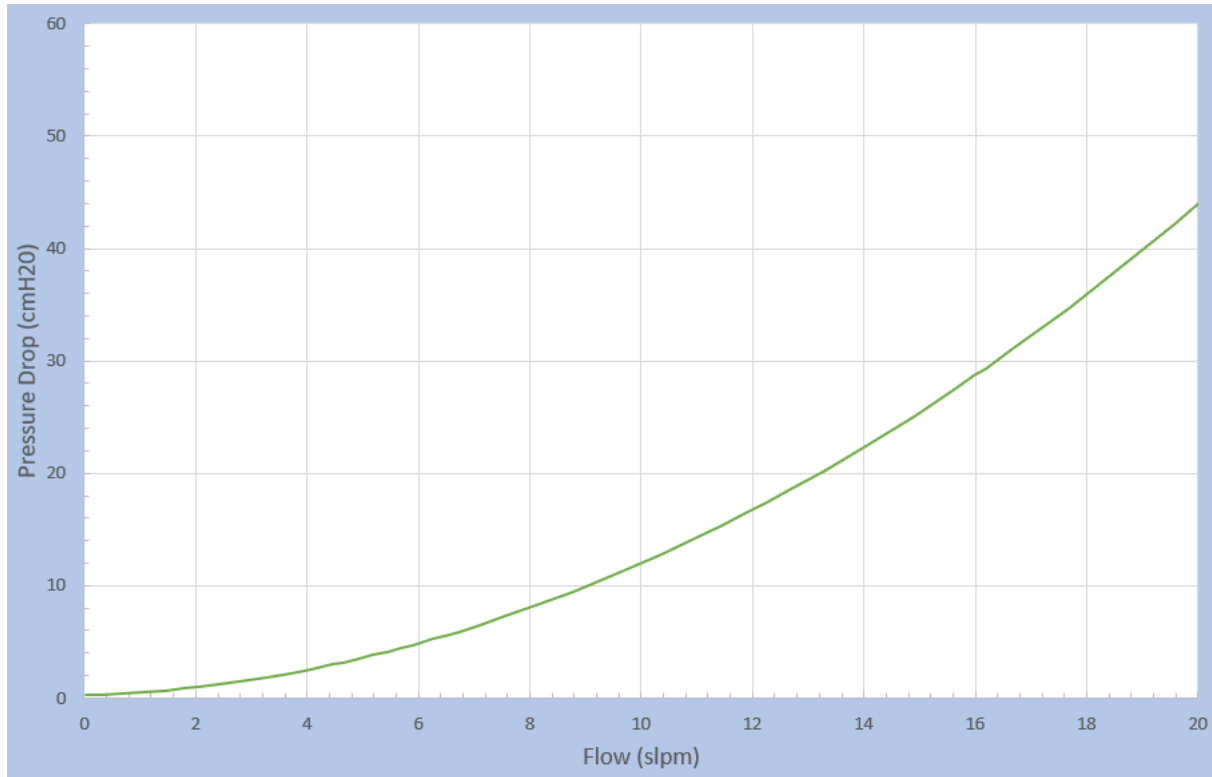

## High Flow Channel

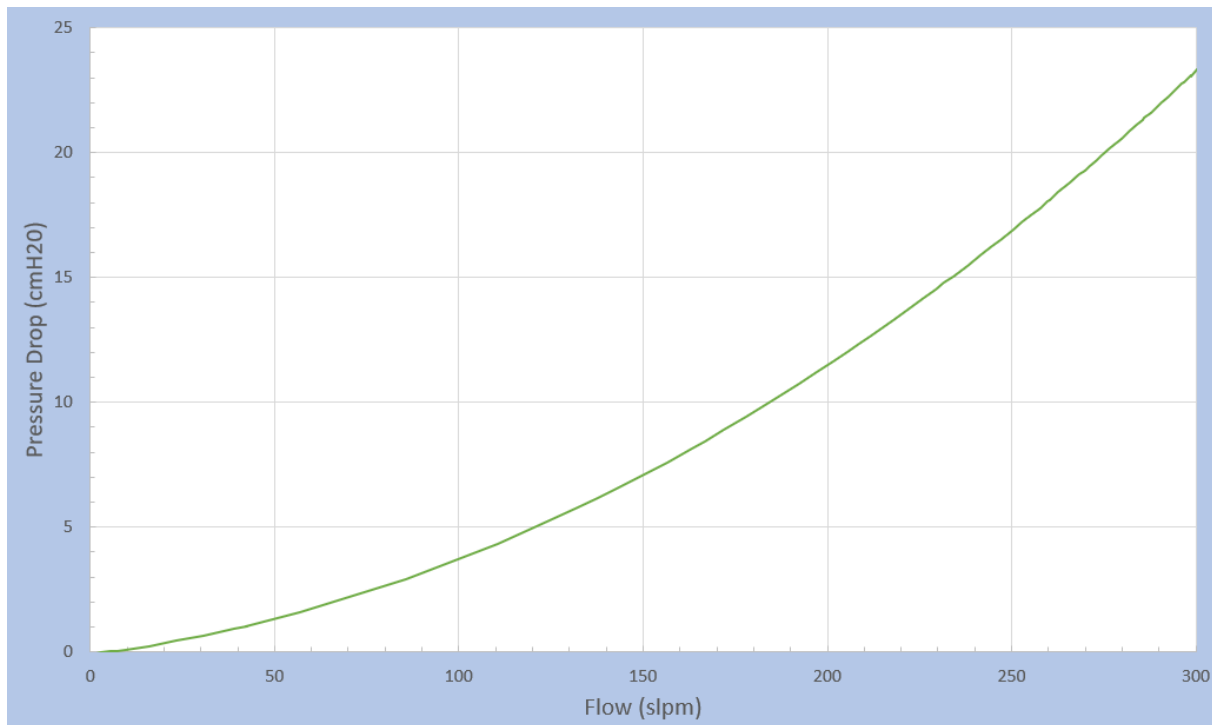

## APPENDIX A

# Data Export Formats

### Snapshot Data File from the Parameter Screen

File Name:	Parameters-2023-01-25T02-46-52.csv					
Data Type:	Parameter					
Number of data points:	1					
Comments:	No Comments					
Configuration:	Trilogy					
Model:	4090					
Serial Number:	40902304002					
Trigger Type:	Auto Trigger					
Breath Average:	5					
Breath Average Time:	0.5 s					
Gas Condition:	ATP					
Gas Type:	Air					
Data Section		Low Flow	High Flow	High Flow	High Flow	High Flow
		Absolute Pressure	Flow Rate	Low Pressure	Inhaled Tidal Volume	Temperature
	Time (HH:mm:ss)	cmH2O	L/min	cmH2O	L	°C
	00:00.0	996	42.63	1.053	0.446	26.7

#### NOTICE

Snapshots initiated from the Parameter screen capture a single data point of the current reading for all measurements selected on the Parameter screen.

### Snapshot Data File from the Graph Screen

File Name:	Graph-2023-01-25T02-46-32.csv		
Data Type:	Graph		
Number of data points:	227		
Comments:	No Comments		
Configuration:	V60		
Model:	4090		
Serial Number:	40902304002		
Trigger Type:	Auto Trigger		
Breath Average:	5		
Breath Average Time:	0.5 s		
Gas Condition:	ATP		
Gas Type:	Air		
Data Section		High Flow	High Flow
		Flow Rate	Low Pressure
	Time (HH:mm:ss)	L/min	cmH2O
	00:00:00.000	-34.9332	0.9453
	00:00:00.066	-32.1207	0.9422
	00:00:00.132	-28.6806	0.9393
	00:00:00.198	-25.4923	0.936
	00:00:00.264	-21.6116	0.9333
	00:00:00.330	-18.1976	0.9302
	00:00:00.396	-14.3164	0.9276
	00:00:00.462	-11.1276	0.925

#### NOTICE

Snapshots initiated from the Graph screen capture all the data currently displayed in the graph at the time the "Save" button is pressed.

# Continuous Log file (Initiated from the Parameter Screen or Graph Screen)

File Name:	Continuous-2023-01-25T02-47-16.csv				
Data Type:	Continuous				
Number of data points:	60				
Comments:	No Comments				
Configuration:	Marquet				
Model:	4090				
Serial Number:	40902305003				
Trigger Type:	FlowRate				
Start Trigger:	3 L/min				
End Trigger:	-3 L/min				
Breath Average:	10				
Breath Average Time:	0.5 s				
Gas Condition:	ATP				
Gas Type:	Air				
Data Section		High Flow	High Flow	High Flow	High Flow
		Flow Rate	Low Pressure	Inhaled Tidal Volume	Temperature
Date (m/dd/yyyy)	Time (HH:mm:ss)	L/min	cmH2O	L	°C
1/25/2023	14:47:22	-9.34	0.924	0.445	27.1
1/25/2023	14:47:23	-0.08	0.92	0.445	28
1/25/2023	14:47:24	-0.05	0.921	0.445	28.2
1/25/2023	14:47:25	31.68	0.995	0.445	28.5
1/25/2023	14:47:26	-33.11	0.945	0.445	26.8
1/25/2023	14:47:27	-9.52	0.924	0.445	27
1/25/2023	14:47:28	-0.09	0.92	0.445	28
1/25/2023	14:47:29	-0.04	0.921	0.445	28.5
1/25/2023	14:47:30	22.01	1.04	0.446	25.9
1/25/2023	14:47:31	-33.12	0.945	0.446	26.8
1/25/2023	14:47:32	-0.43	0.919	0.446	27.7
1/25/2023	14:47:33	-0.07	0.92	0.446	28
1/25/2023	14:47:34	-0.03	0.921	0.446	28.4
1/25/2023	14:47:35	31.11	0.993	0.445	28
1/25/2023	14:47:36	-33.34	0.945	0.445	26.8
1/25/2023	14:47:37	-0.38	0.919	0.445	27.7
1/25/2023	14:47:38	-0.06	0.921	0.445	28.2
1/25/2023	14:47:39	-0.03	0.921	0.446	28.5
1/25/2023	14:47:40	30.56	0.991	0.446	28
1/25/2023	14:47:41	-10.88	1.009	0.446	26.4
1/25/2023	14:47:42	-0.47	0.919	0.446	27.7

# Waveform Log file (Initiated from the Parameter Screen or Graph Screen)

File Name:	Waveform-2023-01-25T02-49-05.csv									
Data Type:	Waveform									
Number of data points:	15000									
Comments:	No Comments									
Configuration:	980									
Model:	4090									
Serial Number:	40902305003									
Gas Condition Low Flow:	ATP									
Gas Condition High Flow:	ATP									
Gas Type Low Flow:	Air									
Gas Type High Flow:	Air									
Data Section		Low Flow	Low Flow	Low Flow	High Flow	High Flow	High Flow	High Flow	High Flow	High Flow
		Flow Rate	Absolute	Temperat	Flow Rate	Low Press	Absolute	Oxygen C	Temperat	High Press
	Time (HH:mn	L/min	kPa	°C	L/min	cmH2O	kPa	%	°C	PSI
	00:00:00.000	0	97.52994	29.69991	-0.12612	0.920334	98.57549	0.003662	28.37069	0.174103
	00:00:00.001	0	97.52994	29.73116	-0.11516	0.92041	98.55625	0.004578	28.39034	0.173798
	00:00:00.002	0	97.58161	29.69991	-0.1055	0.920181	98.54984	0.005112	28.38195	0.173645
	00:00:00.003	0	97.58161	29.69991	-0.09641	0.920715	98.57549	0.005264	28.37069	0.174332
	00:00:00.004	0	97.58161	29.69991	-0.04768	0.920563	98.54984	0.005264	28.38195	0.173187
	00:00:00.005	0	97.58161	29.69991	-0.00226	0.920486	98.54984	0.004501	28.38195	0.173492
	00:00:00.006	0	97.52994	29.69991	0.040579	0.920944	98.56267	0.003586	28.37069	0.173416
	00:00:00.007	0	97.60744	29.69991	0.080479	0.920868	98.56267	0.003281	28.37069	0.174026
	00:00:00.008	0	97.60744	29.69991	0.078563	0.921249	98.54984	0.002823	28.37069	0.173569
	00:00:00.009	0	97.65911	29.69991	0.079093	0.920715	98.52418	0.002899	28.37069	0.173798
	00:00:00.010	0	97.58161	29.69991	0.080956	0.920715	98.57549	0.002747	28.37634	0.171814
	00:00:00.011	0	97.52994	29.69991	0.083937	0.920715	98.56267	0.002899	28.38195	0.173492
	00:00:00.012	0	97.58161	29.69991	0.086302	0.920181	98.52418	0.002823	28.37911	0.174866
	00:00:00.013	0	97.60744	29.69991	0.087035	0.92041	98.54984	0.002975	28.38754	0.173721
	00:00:00.014	0	97.58161	29.67907	0.087584	0.920715	98.57549	0.002899	28.38754	0.173492
	00:00:00.015	0	97.52994	29.69991	0.087744	0.920868	98.54984	0.002975	28.38195	0.172729
	00:00:00.016	0	97.52994	29.69991	0.045413	0.921097	98.54984	0.003281	28.39034	0.173035
	00:00:00.017	0	97.58161	29.69991	0.004269	0.920715	98.60115	0.004272	28.38195	0.172958
	00:00:00.018	0	97.60744	29.67907	-0.03785	0.920715	98.54984	0.004807	28.37347	0.173798
	00:00:00.019	0	97.52994	29.6687	-0.08043	0.920715	98.54984	0.005112	28.38195	0.173721
	00:00:00.020	0	97.52994	29.69991	-0.07987	0.920563	98.60115	0.005112	28.39315	0.17395
	00:00:00.021	0	97.60744	29.69991	-0.07952	0.920563	98.54984	0.005112	28.38754	0.17334
	00:00:00.022	0	97.58161	29.69991	-0.0782	0.920181	98.54984	0.004196	28.38195	0.173645

## NOTICE

The cells in the “Time” column will need to be reformatted in order to display millisecond data properly. To format the cells, select all the data in the column, select “**Format Cells,**” choose the **Custom** category, select h:mm:ss as the Type, and enter “.000” after the h:mm:ss in the Type field.

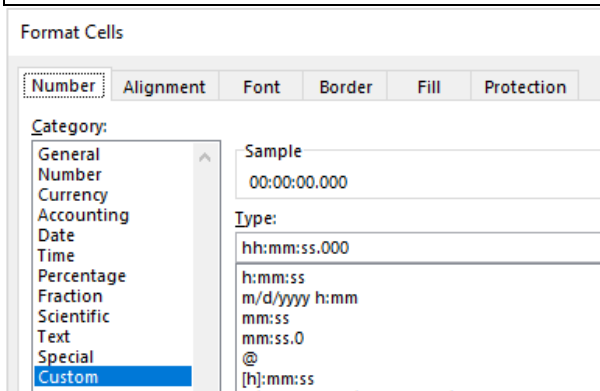

*(This page intentionally left blank)*





**Knowledge Beyond Measure.**

TSI Incorporated – Visit our website [www.tsi.com](http://www.tsi.com) for more information.

<b>USA</b>	<b>Tel:</b> +1 800 680-1220	<b>India</b>	<b>Tel:</b> +91 80 67877200
<b>UK</b>	<b>Tel:</b> +44 149 4 459200	<b>China</b>	<b>Tel:</b> +86 10 8219 7688
<b>France</b>	<b>Tel:</b> +33 1 41 19 21 99	<b>Singapore</b>	<b>Tel:</b> +65 6595 6388
<b>Germany</b>	<b>Tel:</b> +49 241 523030		

P/N 6016808 Rev B

©2023 TSI Incorporated

Printed in U.S.A.



Distributed by:

Kenelec Scientific Pty Ltd  
1300 73 22 33  
[sales@kenelec.com.au](mailto:sales@kenelec.com.au)  
[www.kenelec.com.au](http://www.kenelec.com.au)