

OPERATIONS MANUAL

PC5000



Particle Counter / Grab Sampler

Table of Contents

Contents

SAFETY PRECAUTIONS	5
WARRANTY INFORMATION	6
1.0 GENERAL INFORMATION	7
1.1 BEFORE GETTING STARTED	7
1.2 UNIT LABELING	7
1.3 FEATURES AND BENEFITS.....	8
1.4 SPECIFICATIONS.....	8
1.4.1 WIRING SPECIFICATIONS.....	10
1.5 BASIC THEORY OF OPERATION	10
2.0 INSTALLATION FOR ONLINE USE (CONTINUOUS FLOW)	14
2.1 WEIR ASSEMBLY.....	14
2.2 MOUNTING FOR ONLINE USE (CONTINUOUS SAMPLE FLOW).....	15
2.3 WIRING	15
2.3.1 WIRING OF RS-485 COMMUNICATIONS	15
2.3.2 WIRING OF ANALOG I/O	16
2.3.3 ANALOG INPUT CONFIGURATION.....	16
2.4 SAMPLE SETUP - ONLINE MODE (CONTINUOUS SAMPLE FLOW)	18
2.4.1 SAMPLE CONSIDERATIONS	18
2.4.2 Sample Taps	18
2.4.3 Flow Control.....	19
2.4.4 Flow Control Weir Assembly.....	19
2.4.5 Problems with Air Bubbles.....	20
2.4.6 Initial Startup.....	20
2.5 SAMPLE SETUP - GRAB SAMPLER MODE.....	21
2.5.1 Tubing Connections.....	21
2.5.2 Flow Rate Adjustment.....	21
3.0 PARTICLE COUNTER OPERATION ONLINE MODE (CONTINUOUS FLOW)	23
3.1 USER INTERFACE (KEY PAD)	23
3.2 READOUT / DISPLAY SCREENS.....	24
3.2.1 Main Display Screen.....	24
3.2.2 Total Counts Screen	24
3.2.3 Trend Graph	24
3.2.4 Status Screen.....	25
3.3 USER MENU / SETUP SCREENS	26
3.3.1 User Login	26
3.3.2 Operation Mode.....	26
3.3.3 Sample Setup	27
3.3.4 General Setup	28
4.0 PARTICLE COUNTER OPERATION-GRAB SAMPLER MODE	30
4.1 SAMPLE SETUP.....	30
4.1.1 Hold Output	30
4.1.2 Run Volume.....	30
4.1.3 Purge Volume.....	31
4.1.4 Size Ranges.....	31
4.1.5 Flow Rate.....	31
4.1.6 Count Format	31
4.2 GRAB SAMPLER OPERATION	31
4.2.1 Sample Analysis.....	31

4.2.2	Grab Sampler Data Download	33
4.2.3	Erasing Grab Sampler Data via Service Menu.....	37
5.0	SERVICE AND ROUTINE MAINTENANCE.....	38
5.1.1	Service Setup.....	38
5.2	RS-485/USB COMMUNICATION AND POWER INDICATORS	39
5.3	ROUTINE MAINTENANCE.....	39
5.3.1	Non-brush Cleaning	40
5.3.2	Brush Cleaning	40
5.3.3	Replacing Tubing.....	42
5.3.4	Battery Replacement	42
6.0	RECOMMENDED SPARE PARTS LIST	43
6.1	ORDERING SPARE PARTS.....	43

SAFETY

In order to provide maximum user safety the PC5000 particle counter was designed with the following issues in mind.

- ❑ All electrical circuitry is enclosed within a protective non-conductive housing.
- ❑ No user serviceable parts.
- ❑ No user replaceable parts.
- ❑ No access to laser.

SAFETY PRECAUTIONS

It is important to review this list of precautions prior to installation.

- ❑ Do not attempt to disassemble the unit.
- ❑ Close and fasten shut the cover of the unit prior to any external cleaning to prevent water ingress.
- ❑ Do not drop or jar the unit.
- ❑ Use a mild non-abrasive cleanser when cleaning the outer cover of the unit.
- ❑ Do not modify any internal electrical wiring or electronics.
- ❑ The PC5000 sensor is equipped with a class 3R laser and should not be tampered with in any way.

WARRANTY INFORMATION

Chemtrac, Inc. warrants its equipment to be free from defects in material and workmanship for a period of one (1) year from date of shipment to the original purchaser. Upon receipt of written notice from purchaser, seller shall repair or replace the equipment (at option of Chemtrac, Inc.).

Chemtrac, Inc. assumes no responsibility for equipment damage or failure caused by:

1. Improper installation, operation, or maintenance of equipment.
2. Abnormal wear and tear on moving parts caused by some processes.
3. Acts of nature (i.e. lightning, etc.)
4. The sensor optical alignment is very sensitive to vibration. Avoid installation locations with high amounts of vibration. If drilling of enclosure is necessary, please contact the factory for guidance.

This warranty represents the exclusive remedy of damage or failure of equipment. In no event shall Chemtrac, Inc. be liable for any special, incidental, or consequential damage such as loss of production or profits.

Should you experience trouble with the equipment, please contact:

Chemtrac, Inc

6991 Peachtree Industrial Blvd., Building 600
Norcross, GA 30092

Phone: 1-800-442-8722 (Inside US only), 770-449-6233

Fax: 770-447-0889

Email: chemtrac@chemtrac.com

Website: www.chemtrac.com

1.0 GENERAL INFORMATION

1.1 BEFORE GETTING STARTED

The particle counter is one of the most sensitive and precise instruments in use in water treatment today. In order to achieve and maintain optimal performance, it is imperative that proper installation and operational procedures be followed.

The sensitivity of the unit to small concentrations of particles well below the range of visibility requires that the sample be delivered to the sensor without contamination or alteration. Data produced is based on the sample volume, so flow rate must be maintained at a constant value. The flow path through the sensor is small (750 um x 750 um) in comparison to other types of on-line instruments. Strainers should be used on raw water samples, and a proper maintenance schedule must be followed.

UNPACKING UNIT

When unpacking the PC5000 it is important to follow the following guidelines.

1. Open box right side up.
2. Carefully remove and examine packing material for any loose items that may have fallen out of containers during shipping.
3. Carefully remove items from the box. Verify all items listed on the packing list were received. Contact the factory immediately if any items appear to be missing.
4. Your PC5000 may include the following items.
 - Sampling Kit which consists of the following items:
 - Sensor Tubing (1/8" ID x 6 ft) PN: 11420
 - Inline Filter For Pump Protection (KNF) PN: 11152
 - Qty 1 flow control weir (Optional – for continuous sampling) PN: 34905
 - Qty 2 weir clamps (Optional - for continuous sampling) PN: 34960
 - Qty 1 Sample Drain Cup (Optional – for continuous sampling) PN: 34970
 - Overflow Tubing (5/8 in ID X 5 ft) (Optional - for continuous sampling) PN: 11430
 - Weir Inlet & Drain Cup Tubing (3/16 in ID X 5 ft) (Optional - for continuous sampling) PN: 11425
 - Qty 1 400 Micron In-Line Strainer (Optional, Recommended For Raw or Settled Water) PN: 9875
 - Cleaning Kit which consists of the following
 - Qty 1 cleaning brush PN: 34400
 - RS-485 Communications cable (Optional – for data collection with continuous sampling) PN: 34870
 - Software
 - Grab Sampler Data Download Software
 - TracWare (Optional - for data collection with continuous sampling) PN: 34650
 - Qty 1, Operations Manual

1.2 UNIT LABELING

Each PC5000 particle counter has a serial number label attached to the inside of the enclosure. Please refer to this information when inquiring on your particular unit.

1.3 FEATURES AND BENEFITS

Particle Counter model PC5000 is intended for the determination of particle count and size distribution in a variety of liquid streams. Major applications include monitoring filter performance in potable water treatment plants, detecting contaminants in clean liquids, measuring particle size growth as a function of flocculation or precipitation, detecting particle shedding in medical device testing, and measuring suspended metal oxide corrosion products in steam Generation power plants. Particle counting is generally more sensitive than turbidity measurements for early detection of process changes such as filter breakthrough or contamination of an ultrapure liquid.

The sensor is designed to detect particles in the 2 to 750 μm range (upper limit defined by flow cell size), and size particles in the 2 to 125 μm range (any particles larger than 125 micron will be sized as >125 μm). The PC5000 uses a light blockage method to determine particle size and count. The light source is an infrared laser diode.

The analyzer features an external sampling and measurement. The 750 μm x 750 μm flow cell is easy to access and clean. The constant head, flow control weir ensures stable, reproducible flow and accurate particle counts when the instrument is operated in online mode.

The PC5000 has a LCD backlit display which allows the user to see the individual size ranges and particle counts in each range. The display also provides the cell condition readout, which is an indication of the sensor's cleanliness and allows the user to know when cleaning is necessary. It is recommended to clean the sensor when the cell condition drops by more than 10% from the reading obtained after the previous cleaning.

Another unique feature of the PC5000 is its ability to perform Automatic Sizing Calibration via the user menu and front panel keypads. No software or computer is required to calibrate the PC5000.

1.4 SPECIFICATIONS

GENERAL

Laser Type:	Solid-state Laser Diode (780nm)
Flow cell Dimensions:	750 μm x 750 μm
Cell Material:	Nituff™ coated aluminum (or PEEK plastic – Optional)
Viewing Windows:	Sapphire
Detection Range:	2-750 μm
Sizing Range:	2-125 μm
Flow rate:	75 m/min
Size Channels:	8, user-selectable
Count Format:	User selectable: Counts per ml, Counts per 100 ml, or Raw Counts
Laser Diode Life:	MTBF > 75,000 @ 55°C
Measurement Type:	Volumetric
Local Display:	Graphical, 8 size channels displayed at once, unit info/diagnostic screen.
Display Readout:	Size channel, counts, cell condition (0-100%), laser condition (0-100%), unit address, # of stored data records, sample period, sample frequency, flow rate

Data Storage:	>30,000 Sample Strings, User defined logging interval (1-254 minutes) in Online mode Up to 200 samples with 99 runs per sample in Grab mode.
Graphical Trending:	Last 64 recorded readings, User selectable value trending (e.g. Total Counts, Bin 1, Cell Condition, Analog Input, etc), Online mode only
Keypad Interface:	All instrument settings may be modified via the keypad interface, including instrument calibration (some settings require password)
Serial Communication:	2 wire RS485 (Network) and USB (Local)
Communication Protocols:	Standard: MODBUS RTU (RS485). Optional: MODBUS TCP (Ethernet).
Analog Outputs:	2, 4 or 6* outputs, 4-20 mA (optional) Online mode only
Analog Inputs:	2, 4 or 6* inputs, 0-5V, 0-10V, 0-20 mA, 4-20 mA (optional) Online mode only
Alarm Relays:	1 Dry Contact Relay, 250V, 5A (optional) Online mode only
Power Requirements:	115 VAC, 1A, 47-63 Hz or 230 VAC, 0.5A, 47-63 Hz
Operation Temperature:	32° - 120° F (0° - 50° C)
Dimensions:	12" W x 11.5" H x 5" D (305 mm W x 292 mm H x 127 mm D)
Weight:	7 lbs (3.2 kg)

- * Maximum of 6 inputs/outputs combined.

SAMPLE REQUIREMENTS

Sample Temperature:	32-120° F, (0-50° C), (non-freezing)
Sample Head:	30" (762 mm) water min. Online mode.

CALIBRATION

Standards:	Latex (PSL) microspheres. Standard sizes used for factory calibration: 2, 3, 5, 7, 10, and 15 µm (nominal)
Recommended calibration frequency:	Yearly

Software COMPUTER REQUIREMENTS

Operating system:	Windows XP, Vista, 7, 8
Computer:	Intel or AMD processor (2 GHZ or faster); at least 1 GB of RAM, 20 GB of hard drive space, CD ROM drive

1.4.1 WIRING SPECIFICATIONS

CABLE MINIMUM TEMPERATURE RATING 50° C

□ RS 485 Communications Cable

Belden Wire & Cable – Paired Cable	
For Low Capacitance for EIA RS-485 Applications	
Trade Number:	9841
NEC	CM
UL AWM	2919
CEC	CM
Conductor AWG:	24
Conductor Stranding:	(7x32)
Conductor DCR:	78.7 ohms/km
Conductor Type:	TC
Insulation Type:	Polyethylene
Jacket Type:	PVC
Shield Type:	Beldfoil® + TC Braid
Nominal OD:	0.232" (5.893mm)
Nominal Capacitance:	12.8 pF/ft. (42.0 pF/m)*
Nominal Capacitance:	23.0 pF/ft. (75.5 pF/m)**
Velocity of Propagation:	66%

Description:

Tinned copper, polyethylene insulated, twisted pairs. Overall Beldfoil® aluminum-polyester shield. 24 AWG stranded tinned copper drain wire. Overall tinned copper braid shield (90% coverage). Chrome PVC jacket (100% coverage). 30V 80° C

*Capacitance between conductors

**Capacitance between one conductor and other conductors connected to shield.

1.5 BASIC THEORY OF OPERATION

The Chemtrac Model PC5000 particle counter is designed to "count" particles 2 to 750 micron in diameter and "size" (i.e. sort by size) particles ranging from 2 to 125 microns in diameter. Particles larger than 125 micron will be sized as >125 micron particles. Particles are divided into size ranges and the number of particles counted in each of these ranges can be reported as counts per milliliter, counts per 100 milliliter, or Raw Counts.

The particle counter consists of an optical sensor and counting electronics. The sensor consists of a 780 nm infrared laser diode, a light detector, and two transparent "windows". The detector converts light energy into electrical voltage. The laser light is directed through both windows and on to the detector. Sample flow passes between the windows, so that any particles in the sample will pass through the laser beam. Each particle will block a small percentage of the light that hits the detector, changing the electrical output of the detector. Since the particles are moving rapidly, each particle will produce a short electrical pulse at the output of the detector. The amplitude of the pulse correlates to the size of the particle. The output of the sensor is a stream of pulses of varying amplitude, each corresponding to a particle. This type of device is known as a light blocking or light extinction sensor, see Figure 1.

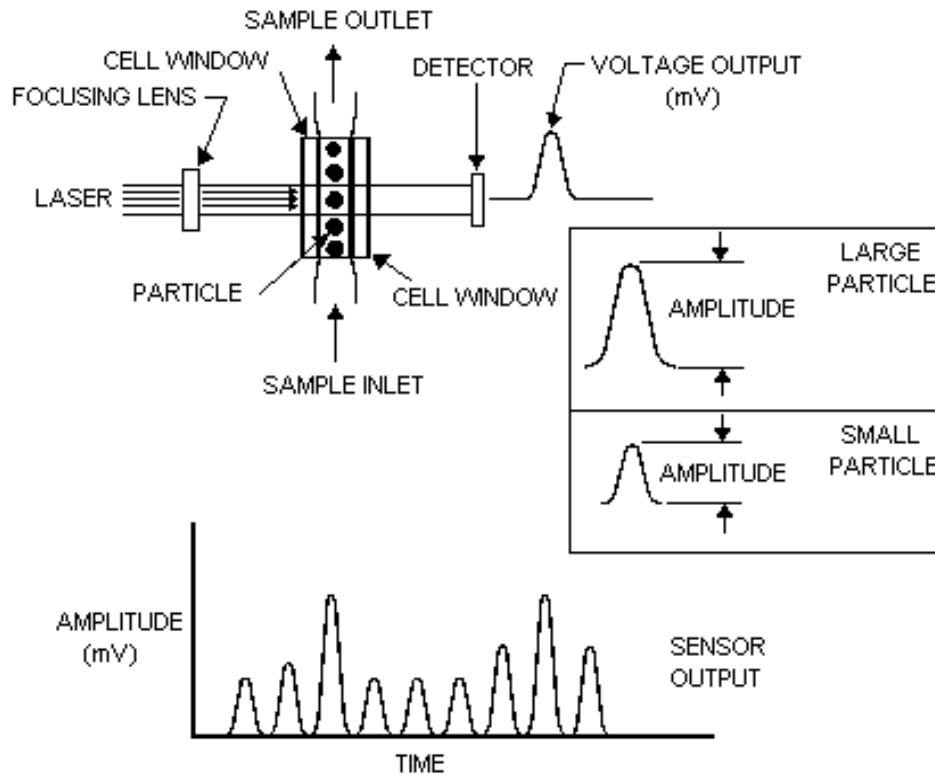

Figure 1 Light Obscuration Measurement (Diagram 1)

The amount of light blocked from the detector is the sum of the light absorbed by the particle and the light scattered or reflected by the particle. The size and composition of each particle will determine how much light is scattered and how much is absorbed. Carbon particles will absorb most of the light and scatter very little of it. Organic particles have an index of refraction close to the value of water, and tend to refract more light. The result of this is that an organic particle 5 microns in size will block less light than an inorganic particle of the same size, and will appear smaller to the particle counter. For this reason, Giardia and Cryptosporidium will be counted in size ranges several microns below their actual size. The orientation of the particle as it passes through the light beam will also affect how much light is blocked. These factors make it necessary to count particles over a range of sizes as opposed to an exact size.

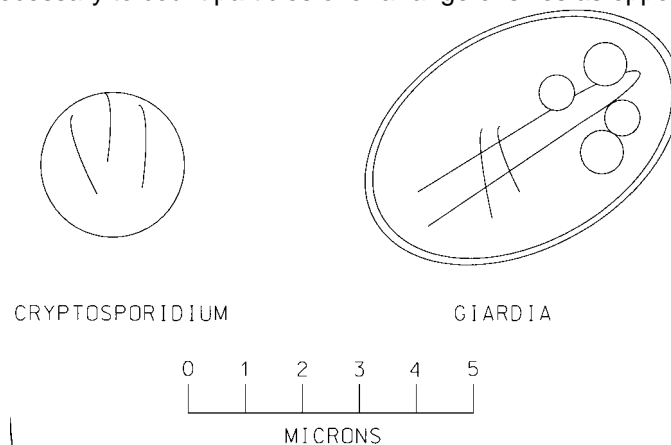

Figure 2 Particle Size Comparison

The sensor output is fed into the counter electronics, which sorts the pulses according to amplitude and counts them. In a typical application, three or four ranges might be used. The first one might be set to count particles in the range from 2 to 5 microns, the second 5 to 10, the third 10 to 15, and so on.

The Model PC5000 typically operates at a flow rate of 75 ml/min. The Flow Control Weir, which is a constant head overflow device, is used to maintain this flow when in online mode. Flow adjustment is accomplished by moving the drain cup up or down the weir assembly, which decreases or increases flow (See Section 2.4.4). In Grab Sampler mode, the flow rate is controlled by adjusting the pump speed dial on the side of the unit. (See Figure 3) Other flow rates can be used and are set via the user menu. However, the instrument is calibrated at the factory for a flow rate of 75 ml/min and the sizing accuracy will not be accurate if that flow rate is changed by more than 10% and the unit is not recalibrated at the new flow rate. If your application requires the flow through the sensor to be something different than 75 ml/min, then contact the factory for assistance.

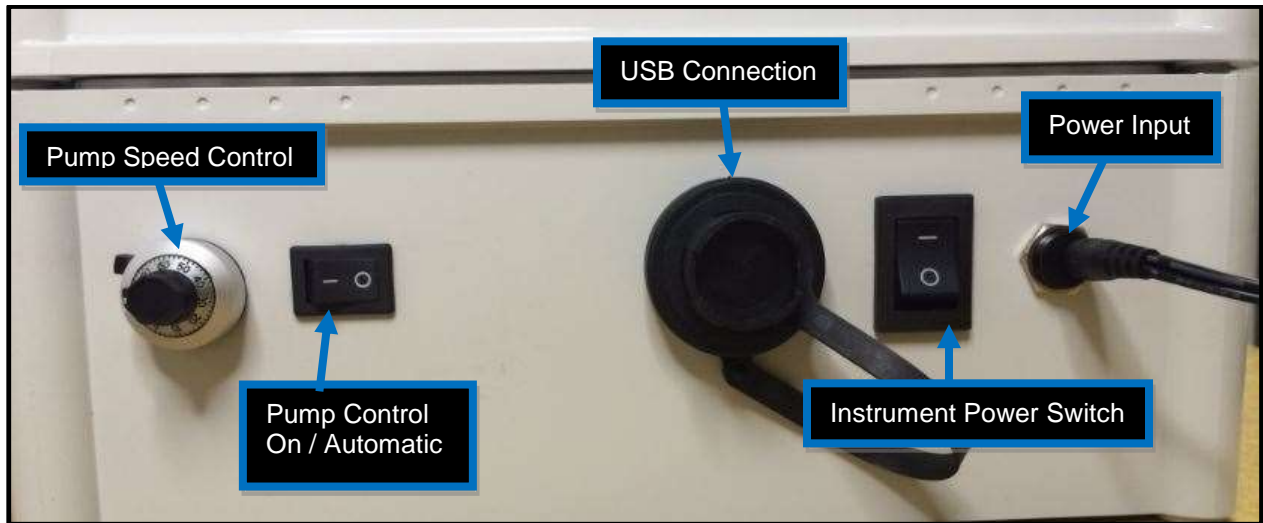

Figure 3

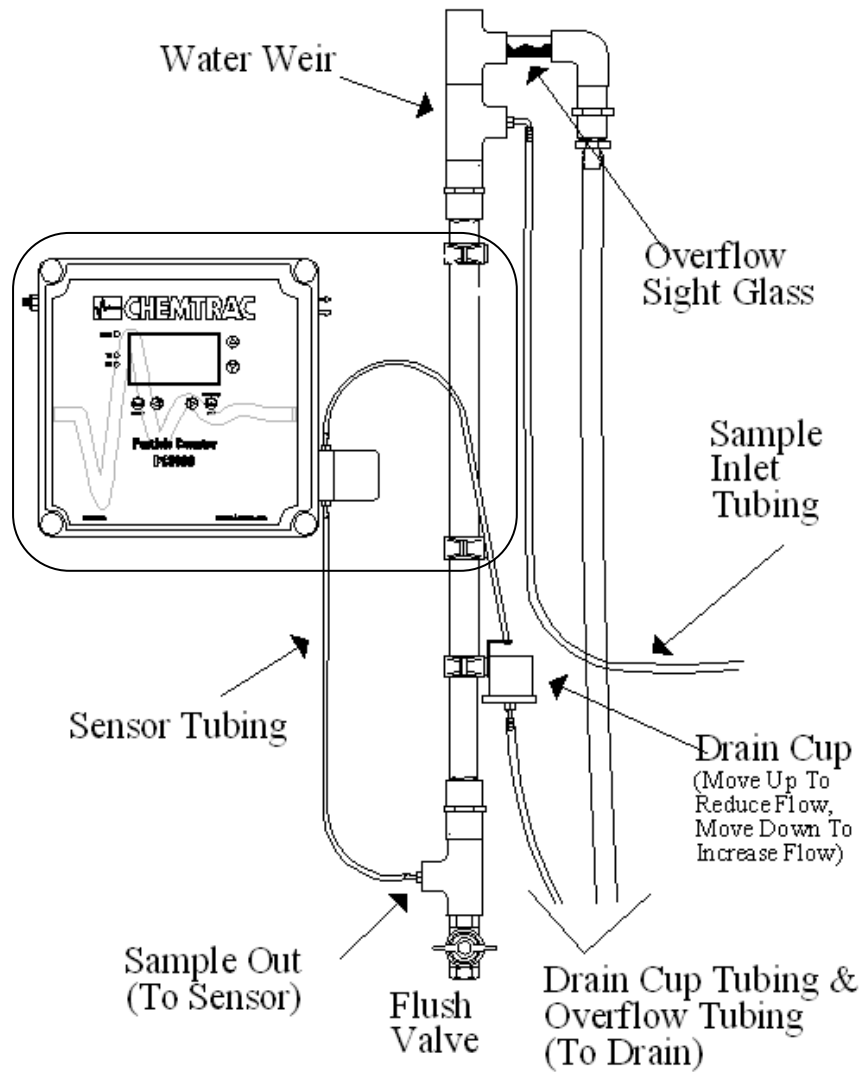

Figure 4
PC5000 and Flow Control Weir Plumbing for Continuous Sampling (Online Operation)

2.0 INSTALLATION FOR ONLINE USE (CONTINUOUS FLOW)

NOTE

While installing the PC5000, avoid excessive vibration, dropping, or banging on the unit. The optics inside the sensor can be knocked out of alignment if the unit is improperly handled.

2.1 WEIR ASSEMBLY

Prior to mounting the PC5000, it will be necessary to assemble the weir. The weir comes unassembled in three pieces. Those three pieces are simply screwed together to look like the weir shown in the below diagram.

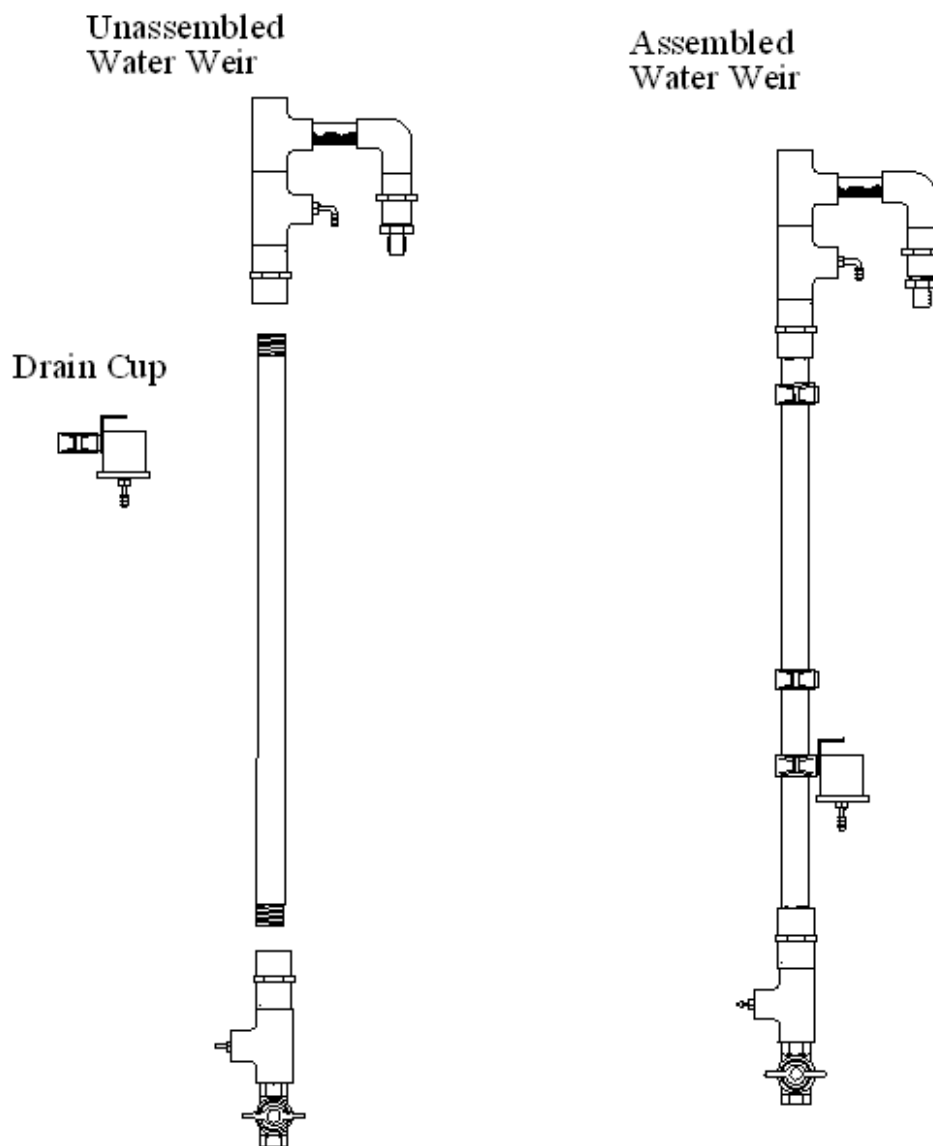

Figure 5 Weir Assembly

2.2 Mounting for Online Use (Continuous Sample Flow)

If the PC5000 is to be used for continuous online monitoring, it should be permanently mounted to a flat, vertical surface, such as a wall or support column, in an upright position using the 4 mounting holes located at the top and bottom of the back plate. The weir mounting arms should be mounted to the PC5000 backplate using the mounting holes and clamps that are provided. The weir height should be adjusted so that the top of the weir is approximately 10 to 12 inches above the top of the PC5000.

The weir assembly and PC5000 should be mounted at an elevation sufficient to achieve overflow at minimum source pressure. A ball valve can be used to regulate the flow into the weir assembly.

Once the PC5000 and Flow Control Weir are mounted, the tubing can be attached to the Weir and Sensor as detailed in Figure 4. Make the sensor tubing going between the sensor and drain cup long enough to reach the drain cup with it slid all the way down on the weir. It is also recommended to leave a little extra tubing on the bottom of the drain cup. Final adjustment to the drain cup position and tubing lengths will be made in section 2.4.4.

2.3 WIRING

WIRING SAFETY - Please observe the following safety precautions prior to wiring the unit.

- ❑ All cables must meet the minimum temperature rating of 50 degrees Celsius.
- ❑ Power must be locally fused or switched prior to entering the unit.

2.3.1 WIRING OF RS-485 COMMUNICATIONS

If utilizing RS-485 Communications, connect the RS-485 Cable to the RS-485 terminals shown in Figure 7. Ensure shielding is tied together and connected to ground at one end.



Figure 7 Analog IO and RS-485 Communications

2.3.2 WIRING OF ANALOG I/O

When utilizing 4-20 mA outputs, 4-20 mA inputs, voltage inputs, or relays, signal wiring will be done at terminal J4. Because of the variety of Analog I/O options available, it is not practical to identify the precise wiring locations in the scope of this manual. A label adhered to the inside of each PC5000 will indicate the precise wiring locations for any optional I/O included with each individual particle counter.

2.3.3 ANALOG INPUT CONFIGURATION

The PC5000 analog inputs can be configured for either 0 - 5 VDC, 0 - 10 VDC or 0 - 20 mA (4 - 20 mA). The input type is selected via the General Setup -> Outputs & Alarms menu. (See 3.3.3.4) Once the input type is determined, jumper settings on the analog input card must be configured to match the input type. See Figure 8

Information from the analog inputs is available over any of the digital communications options (RS485, Modbus TCP). In addition, analog input data, for the first 4 input channels, is logged in the instruments memory. The data is logged based on the interval selected in the General Setup -> Log Frequency menu. It is also possible to select one of the analog input signals for trending on the Trend Graph. (See 3.3.3.1)

NOTE

Information from the analog inputs will only be available and logged when the PC5000 is operated in Online mode.

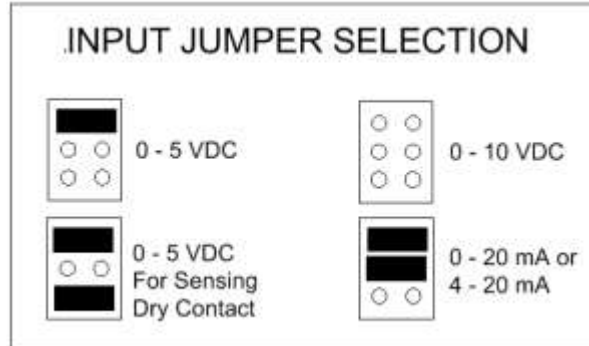

Figure 8 Analog Input Type Jumper Selection

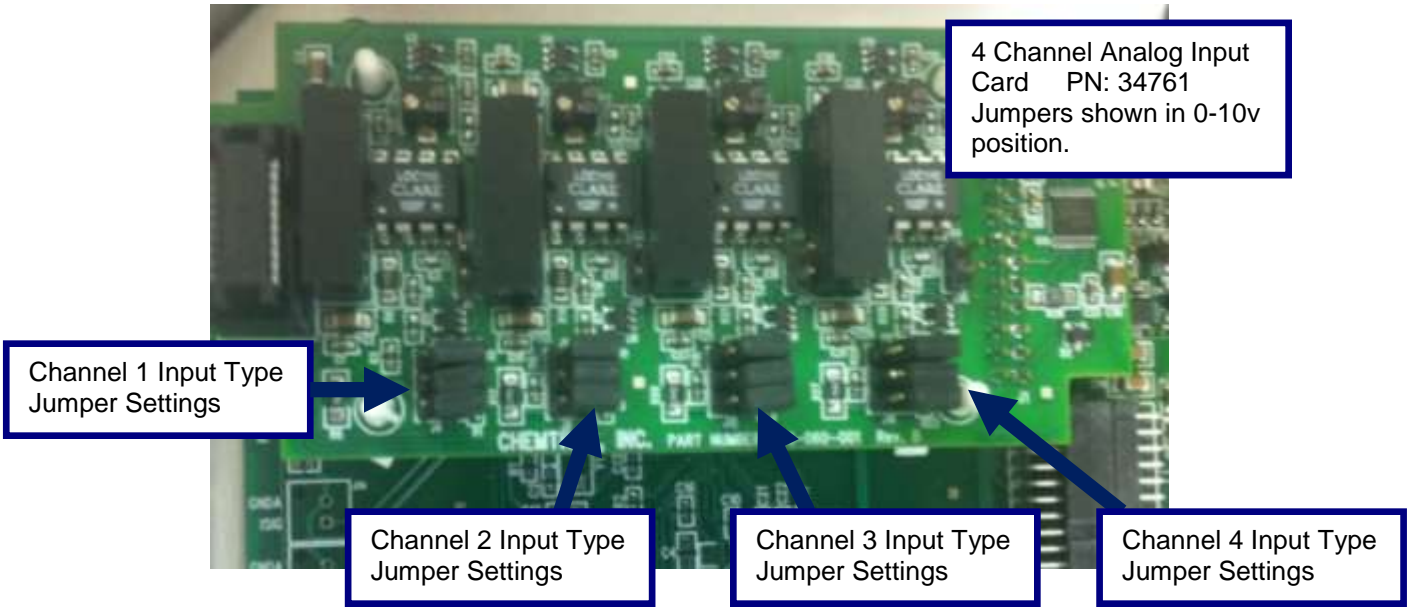

Figure 9 Optional Analog Input Card

2.4 SAMPLE SETUP - Online Mode (Continuous Sample Flow)

2.4.1 SAMPLE CONSIDERATIONS

The high sensitivity of the particle counter makes sample handling and delivery critical for proper operation. Poor sample point selection and/or improper sample line installation can result in a substantial loss of accuracy.

It is not difficult to achieve proper sample delivery in virtually any treatment plant. The important thing is to make sure the sample is properly representative of the process stream. There are three ways in which the sample can be distorted:

1. Adding particles to the sample stream. Choosing an improper location for the sample tap, such as the bottom of a pipe where sediment can accumulate, or an open sample point where particles can be introduced from outside the process usually causes this.
2. Losing particles from the sample stream. Long sample lines can cause particle dropout, especially at low flow rates. If the sample line must be long (more than 10 or 15 feet) then it will be important to keep the sample flowing swiftly (i.e. 4 ft per second) to prevent particulate from settling out in the tubing. The higher flow rate will also help keep the tubing cleaner and thereby help minimize particle shedding which can be caused by fluctuations in flow.
3. Altering the particle distribution. Sample pumps can chop up larger particles creating more small particles. Valves and other obstructions can cause "shedding". Particles collect on cracks and edges and then break loose later. "T" fittings can cause larger particles to miss the sample line because they can't make the sharp right angle "turn".

Of course, it is seldom possible to avoid all of these pitfalls. Frequently valves are needed to control sample flow rates, or pumps are used to get the sample to a usable point. The important thing is to minimize these problems. Filtered water can be pumped with fewer problems than raw or settled, since only very small particles are usually present, and they are less likely to be broken up. Ball valves or other types with minimal edges to trap particles can be used. "Y" fittings can be used instead of "T's".

2.4.2 Sample Taps

The diagram below (Figure 10) shows proper and improper sample locations on a process pipe. These are the same as for any instrument requiring a representative sample flow.

Make sure that the sample point has the minimum pressure available at all times to provide enough flow. The Chemtrac sensor requires approximately 2 feet of head to maintain a 75-ml/min flow, so ensure there will be a minimum of 2 feet of head throughout the entire filter run (i.e. during high head loss towards the end of filter run).

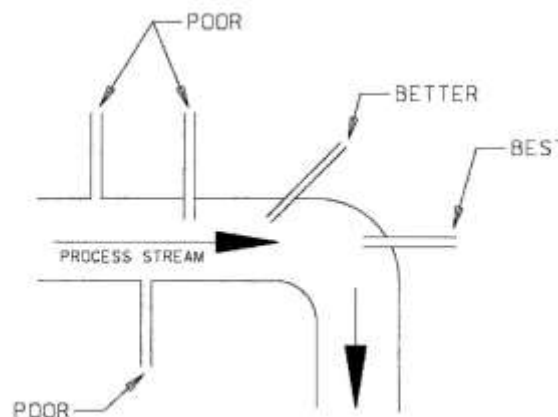

Figure 10 Sample Tap

2.4.3 Flow Control

Since all particle count data must be based on a sample volume, flow control is crucial to accurate and repeatable performance. The simplest and most effective way to achieve constant flow is using the flow control weir. As long as enough flow is delivered to maintain some overflow in the weir, a constant flow will be present in the sensor. If this requirement is maintained, flow will only be altered by clogging of the sensor flow cell or fouled tubing and/or barb fittings. The Chemtrac particle counter comes equipped with a sample drain cup.

2.4.4 Flow Control Weir Assembly

The flow control weir assembly is designed to deliver constant flow to the sensor despite changes in source pressure. Overflow (as seen through the clear horizontal pipe) must be maintained to ensure that full flow is achieved. The clear horizontal pipe at the top of the assembly gives an indication of the amount of overflow. If the level in this pipe reaches the top, or if there is no overflow at all, the flow to the sensor will be affected. It is best to keep the overflow at the midpoint in this pipe to allow for variations in source pressure. An inlet flow to the weir of at least 200 mL/min and not greater than 1000 ml/min should be delivered to the weir to ensure proper flow through the sensor.

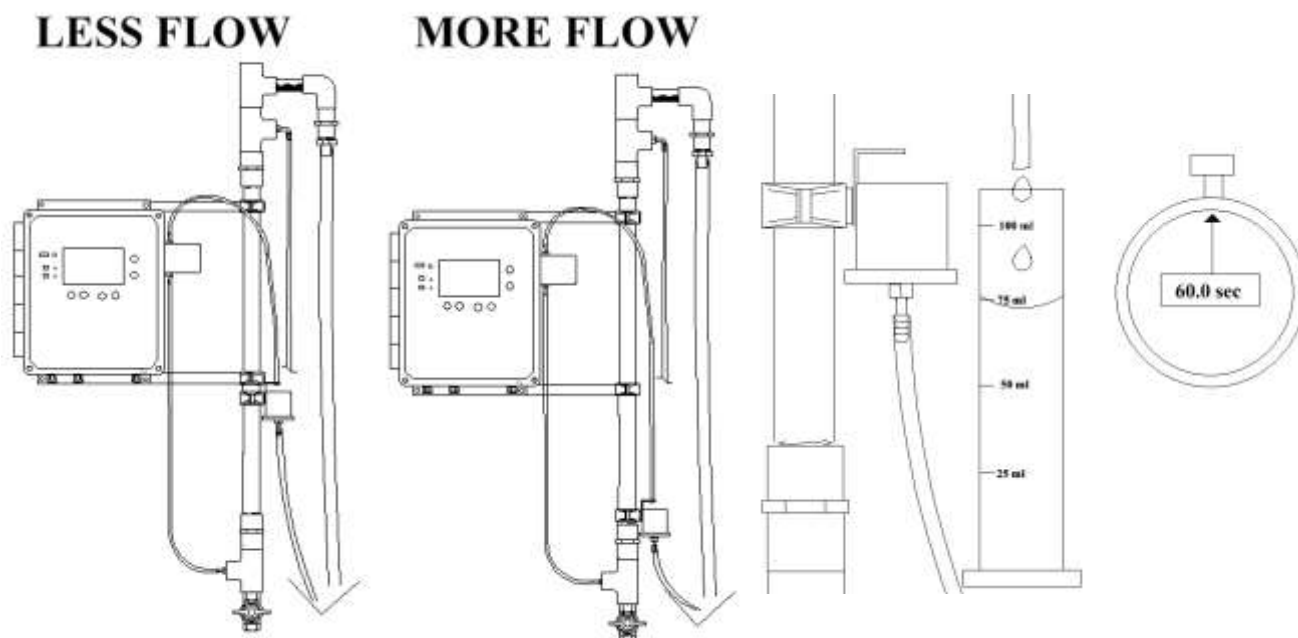

Figure 11 Sensor Flow Rate Adjustment

The flow rate through the sensor is adjusted by moving the Drain Cup up or down the vertical pipe until a 75 ml per minute flow is achieved. Measure the flow rate using a graduated cylinder and a stopwatch. Once the flow is set, the flow will remain stable as long as some amount of overflow is maintained at the top of the weir. The head required to achieve the 75 ml/min flow rate is approximately 24 to 30 inches (as measured from the clear horizontal pipe down to drain cup's tubing holder). Changes in water temperature, as well as the sensor & tubing getting dirty, will affect the flow rate.

As part of the regular maintenance cycle, periodic checks should be made to the flow rate. If the flow rate is found to be low, try replacing the sensor tubing if it looks dirty and clean the sensor as outlined in section 3.5. If this maintenance action does not achieve the proper flow rate, then adjust the Drain Cup up or down the weir to obtain the proper flow rate of 75 ml/min.

2.4.5 *Problems with Air Bubbles*

Bubbles can be introduced into the sample through various means (air in-leakage from loose fittings, degassing from temperature changes and/or pressure changes, etc.). The particle counter will count bubbles as particles if they are large enough, just as a turbidimeter will detect air bubbles as turbidity.

The flow control weir is designed to aid in the removal of air bubbles. However, air bubbles that have formed due to degassing are difficult to remove using the flow control weir. In some cases, the sample may need to be kept pressurized through the sensor to avoid the formation of bubbles. Contact the factory for assistance if you suspect air bubbles are interfering with the measurement. Air bubbles forming in the sensor tubing is a possible indication that air bubbles may be a problem.

2.4.6 *Initial Startup*

It is very important to flush out all taps and valves before connecting the particle sensor to help avoid plugging.

Once installation is complete and the sample is hooked up to the sensor, the sample lines may still be somewhat dirty and not truly representative of the actual particle concentration at the sample point. Typically the sample lines will sufficiently flush and stabilize within 15 to 30 minutes. If the particle counter output is being trended, it is easy to tell when the lines have been sufficiently flushed, as the data will level out.

Once the counts have appeared to stabilize, a quick test can be done to verify the PC5000 is not experiencing any sort of noise issue that can arise due to issues with poor electrical grounding. Simply pinch the tubing coming off the top of the sensor (which is the tubing going to the drain cup). Pinching this tubing will stop flow through the sensor. If the flow is stopped and the tubing held stationary, the counts should drop to zero within 1 to 2 minutes providing the sample is filter effluent (use DI water if filter effluent is not available or is higher than 0.3 NTU).

With water flowing through the sensor, a check should be performed to make sure the PC5000 has a laser and cell condition reading of 90 to 110% as seen on the Status screen. Try cleaning the sensor as detailed in section 3.5 if the cell condition is below 90%. Contact factory for assistance at 770-449-6233 if the cell condition does not come up after cleaning, and/or if the laser is outside of the 90 to 100% range. NOTE: Laser and Cell condition are temperature dependent, so water and/or air temps near freezing or above 100 degrees F can cause these readings to change. The PC5000 is working properly as long as the laser and cell condition reading are in the 90 to 100% range with water and air temps in the 40 to 90 degree F range.

At this point the unit should be ready for user customized menu setup and operation.

2.5 SAMPLE SETUP - Grab Sampler Mode

2.5.1 Tubing Connections

The pump in the PC5000 particle counter is designed to draw the sample through the sensor to avoid any potential contamination. Tubing should go from the sample into the bottom of the sensor, and from the top of the sensor it goes through the filter and into the pump inlet, and then from the pump outlet to drain. See Figure 12

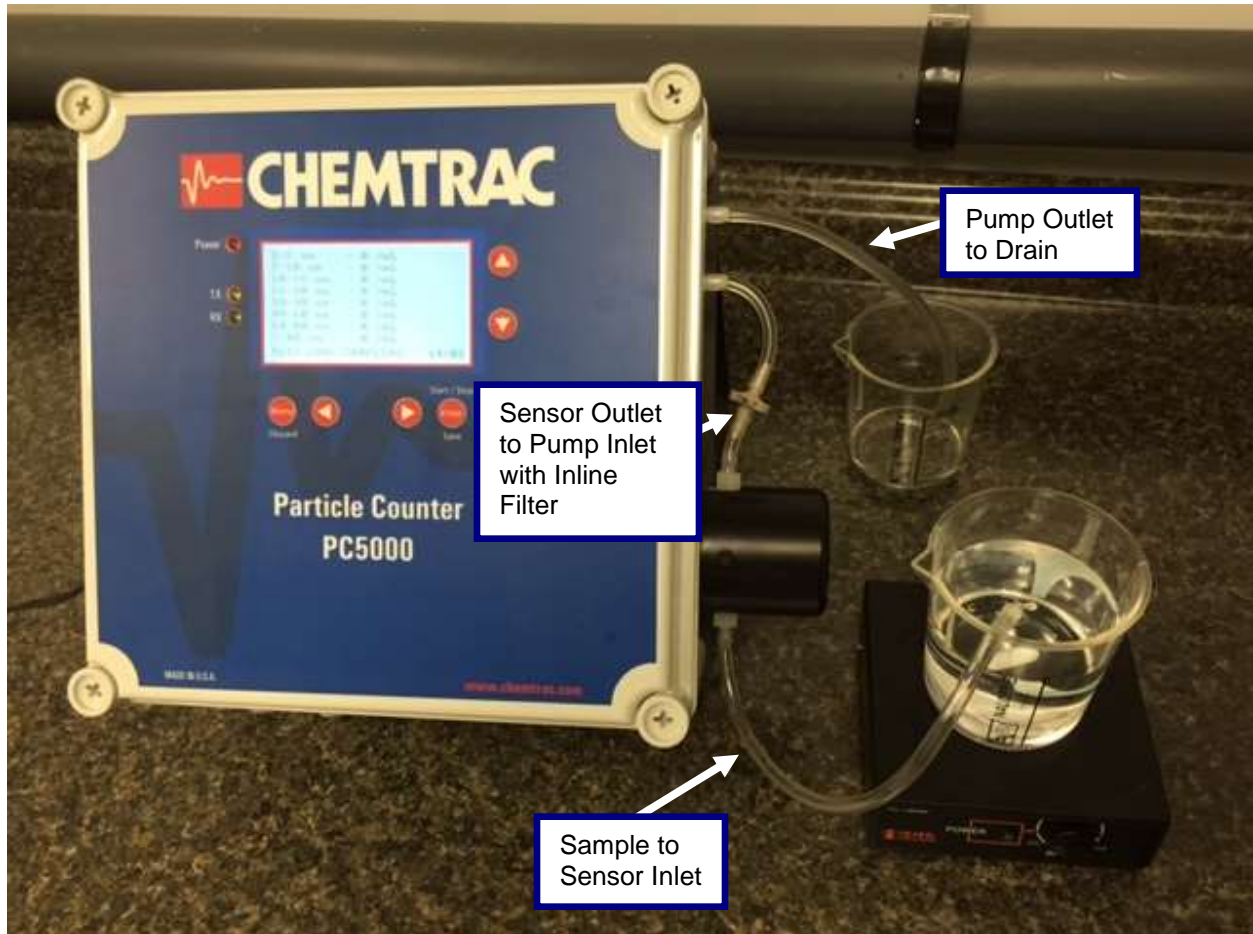

Figure 12 Tubing Connections for Grab Sampler Mode

2.5.2 Flow Rate Adjustment

When using the PC5000 in Grab Sampler mode, the built in pump will automatically operate to draw the programmed amount of sample fluid through the sensor. Prior to running samples through the particle counter sensor it is important to ensure the flow rate is set appropriately (75 mL/min unless otherwise specified). The pump speed control dial on the left hand side of the instrument (See Figure 3) is used to set the proper pump speed for the desired flow rate.

Option 1 For Setting Pump Speed Dial For Proper Flow Rate

With a container of clean water plumbed to the PC5000 as shown in Figure 12, place the pump control switch (located on left hand side of unit, see figure 13) in the "On" position. While monitoring the flow rate at the pump outlet to drain, either via a flow meter or a graduated cylinder with stopwatch (similar to Figure 11), adjust the pump speed control dial until the proper flow rate of 75 ml/min is achieved.

Option 2 For Setting Pump Speed Dial For Proper Flow Rate

1. Go into the Menu and set the unit for Grab Sample mode, and then navigate to Sample Setup. Set the purge volume for 10 ml and a run volume of 15 ml, and set for just 1 sample run (these settings will provide a total of 25 mL dispensed volume when a test is ran, assuming the pump speed dial is set properly). Exit the menu by pressing “Menu”, but do not perform an “Exit And Save” (this is so that previously used grab sample setting can be quickly restored by cycling the power on the unit). After exiting the menu, verify the display shows “Purge Volume: 10 ml, Sample Volume: 15 ml, Number of Runs: 1”.
2. With a container of clean water plumbed to the PC5000 as shown in Figure 12, prime the tubing and pump and flush out any air bubbles by placing the pump control switch (located on left hand side of unit) into the “On” position. Once primed, turn the pump control switch off.
3. Place the outlet tubing in a 50 cc graduated cylinder and start a test by hitting the Enter (start/stop) key on the front keypad. Let the unit complete the test and then verify 24 to 26 mL was dispensed (10 ml purge + 15 ml sample run). If the volume dispensed was outside this range, adjust the pump speed dial on the left hand side of the unit and run another test. Continue in this fashion until the 24 to 26 mL dispense volume is achieved.
4. Lock down the pump speed dial using the switch on the side of the dial so that it is not accidentally moved after it has been properly set.
5. Once the dial is set, turn the PC5000 off and then back on and the previously used grab sample settings will be restored (assuming an “Exit and Save” was not performed in step 1).

The dispense volume should be checked using one of the above options on a regular basis to ensure the flow is properly maintained. Once the dial is set, turn the PC5000 off and then back on and the previously used grab sample settings will be restored (assuming an “Exit and Save” was not performed).

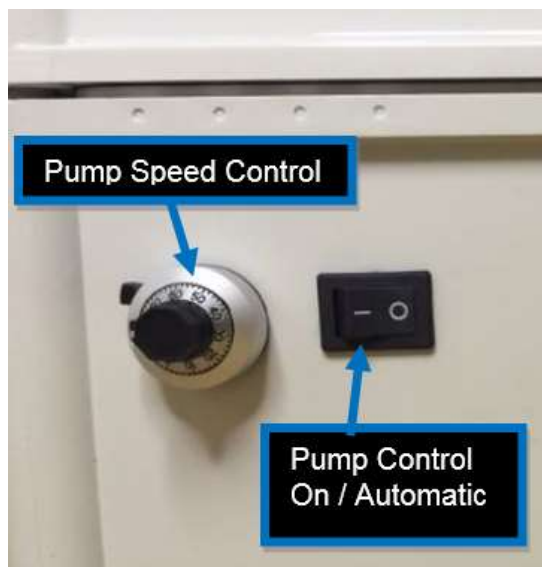
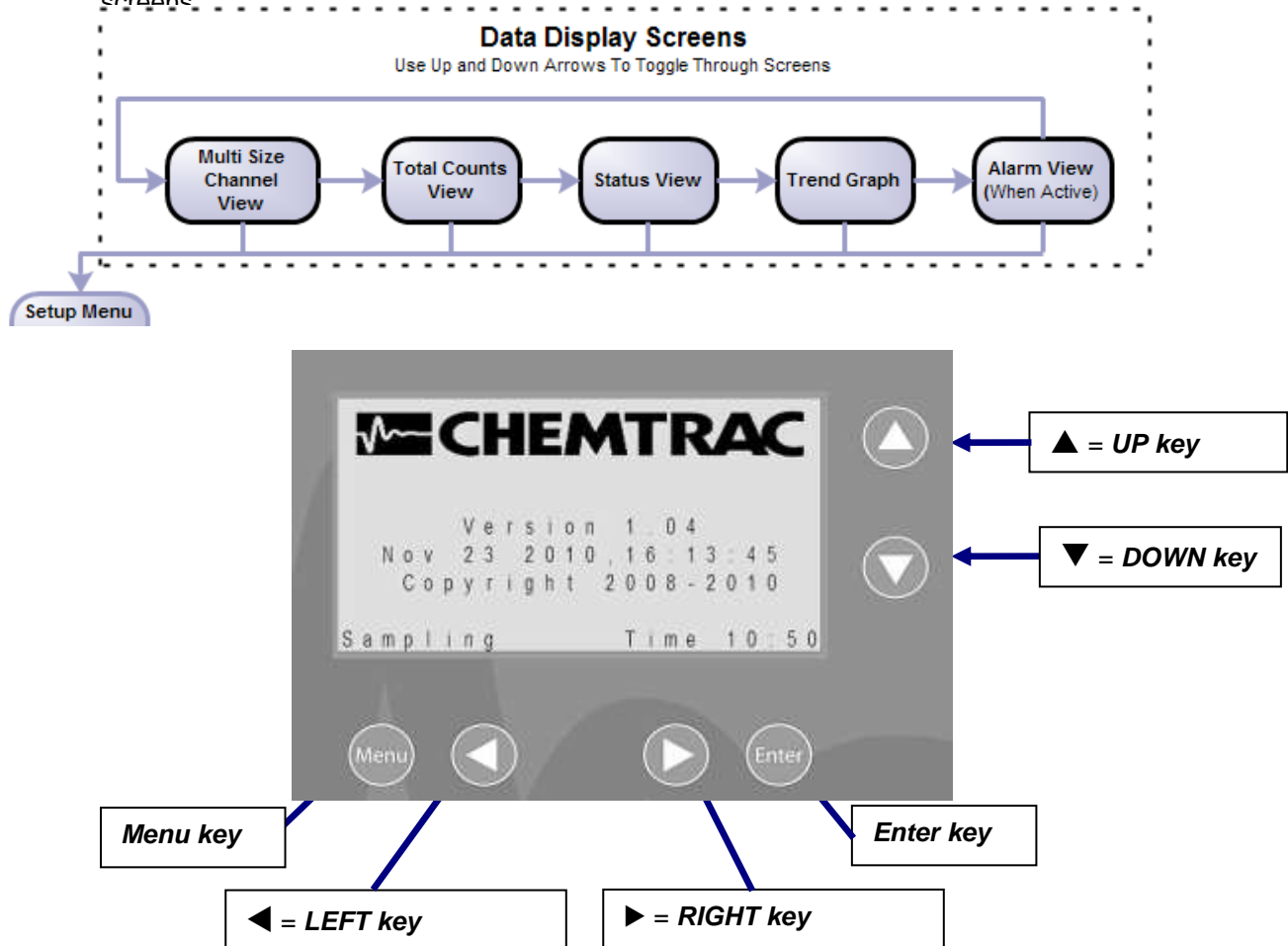

Figure 13

3.0 PARTICLE COUNTER OPERATION ONLINE MODE (CONTINUOUS FLOW)

3.1 USER INTERFACE (Key Pad)

The PC5000 is equipped with user interface keys, and LED indicators. The interface keys are up (▲), down (▼), left (◀), right (▶), and the Menu and Enter function keys. On power up, you see the screen below. In the Appendix of this manual there is a flow chart of display and menu screens.



There are three LED lights to the left of the graphical display. These are:

- ❑ Power – Red LED that illuminates when there is power to the unit.
- ❑ TX – Yellow LED that illuminates when the unit is transmitting data.
- ❑ RX – Green LED that illuminates when the unit is receiving data.

3.2 READOUT / DISPLAY SCREENS

3.2.1 Main Display Screen

Upon completion of first sample period, the screen will update with the measurement results broken out by size range.

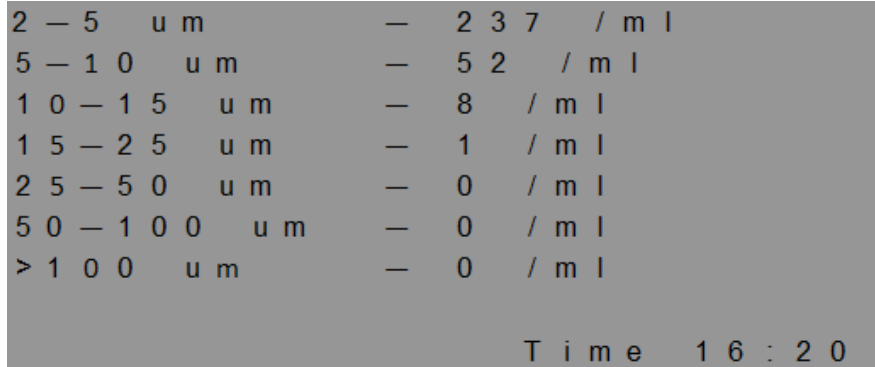

3.2.2 Total Counts Screen

Press the **Down Arrow** to view the Total Counts screen.

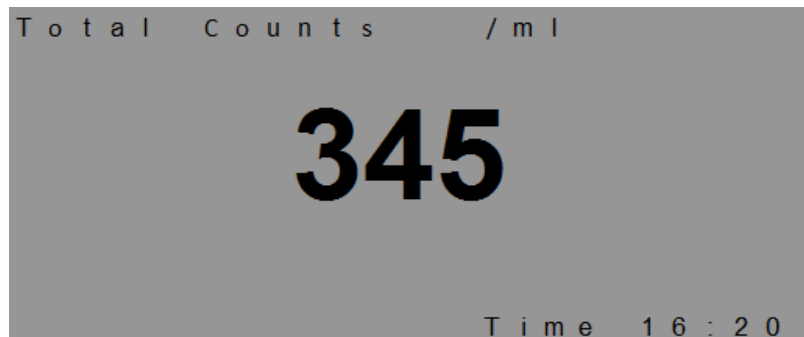

3.2.3 Trend Graph

Pressing the **Down Arrow** key again will bring up the Trend Graph screen. The cursor (the down arrow in the screen) can be moved across the graph by the left and right arrow keys. The samples viewed are the last 64 samples that are logged. Any of the logged values can be mapped to the Graph via the User Menu. This includes Total Counts, individual Bin counts, Cell Condition, Analog Inputs, etc.

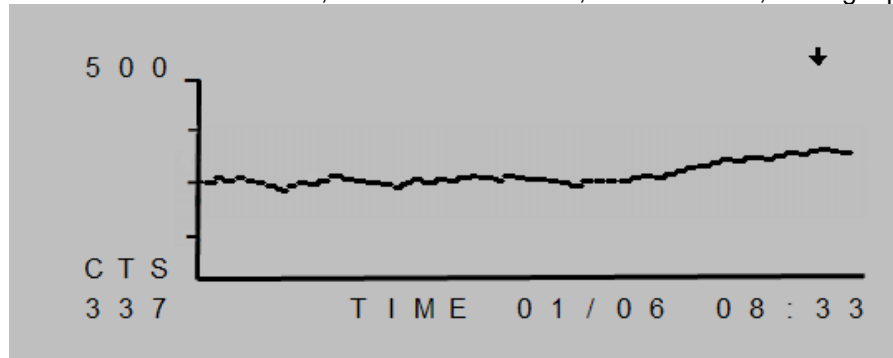

3.2.4 Status Screen

Pressing the **Down Arrow** key again will access the Status Screen.

S T A T U S	
U n i t : 1	V e r : 1 . 0 7 h
S a m p l e # : 3 1 2	
M e m o r y : 4 5 %	D a y s : 2 5
S a m p l e P e r i o d : 1 5	
S a m p l e F r e q u e n c y : 6 0	
L a s e r : 1 0 0 %	C e l l : 9 8 %
F l o w R a t e : 7 5 m l / m i n	
S a m p l i n g	T i m e : 1 6 : 2 0

Unit Address: The units unique address which is used to identify the unit for digital communications (e.g. MODBUS RTU).

Ver: Shows the firmware version the unit is programmed with.

Sample #: Number of measurements taken since the unit was last powered on. This number will rollover back to 1 when the number reaches 1440. This number will reset to 1 whenever an “Exit & Save” is performed from the menu. The main purpose if the Sample # is just to provide an indication that the PC5000 is performing measurements at the proper interval.

Memory / Days: The PC5000 can hold up to 65,000 data strings stored in internal memory and the % value shown here indicates how full the memory is. The “Days” readout indicates how many days until the memory will be full.

NOTE: Once the memory is 100% full, the PC5000 will display “Overwrite”. This indicates that the PC5000 is writing the newest data over top of the oldest data in memory. Data that is written over will not be available for download. After downloading data, the user can erase the memory by going to Menu>Service Setup>Resets>Erase Data Memory.

Sample Period: Number of seconds that a measurement lasts. Default value is 15 sec.

Sample Frequency: Number of seconds between the start of measurements. Default value is 60 sec.

Laser: Percentage readout reflecting changes in laser operating current. This value is provided for diagnostic information only. Laser current will change as a function of laser temperature and age. The laser percentage will increase over the lifetime of the laser and also when ambient air or water temperature increases. With yearly calibrations, a laser percentage between 90 to 110% is considered normal.

Cell: Percentage readout reflecting the cleanliness of the sensor. The sensor should be cleaned after there has been a 10% decrease following the previous cleaning. Note: Changes in temperature which affect the laser percentage will also have an effect on the cell percentage. When the laser percentage drops as a function of cooler temperatures, a corresponding drop in the cell percentage is to be expected. With yearly calibrations, a cell percentage between 90% to 110% after cleaning is considered normal.

Flow Rate: Flow rate value entered into and being used by the PC5000 electronics to calculate count/ml or count/100ml data. Note: Standard factory calibration is performed at 75 ml/min. The user can change the Flow Rate value via the User Menu and set the actual flow rate to match (e.g. 60 ml/min), but particle sizing may not be accurate if the unit has not been calibrated at that flow rate.

3.3 USER MENU / SETUP SCREENS

NOTE:

The PC5000 will not communicate (RS485 or Ethernet) nor will it perform any measurements while in the Setup menu. The PC5000 will exit the menu and return to normal operation if the unit is left in the Setup menu for 5 minutes with no activity.

NOTE:

When exiting the Menu, it is necessary to select “**Exit and Save**” in order to store any changes to permanent memory. Alternatively, if the Menu is exited by pressing the Menu button, the changes will be saved to temporary memory only and changes to settings will be lost if the power is cycled off and on.

If changes were made to the settings that you do not wish to keep, simply exit out of the menu using the Menu button (do not perform an “Exit and Save”) and then turn the unit off and then back on. This will erase any and all changes made to the menu since the last time an “Exit and Save” was performed.

Press the **menu** button to access the PC5000 **SETUP** screen.

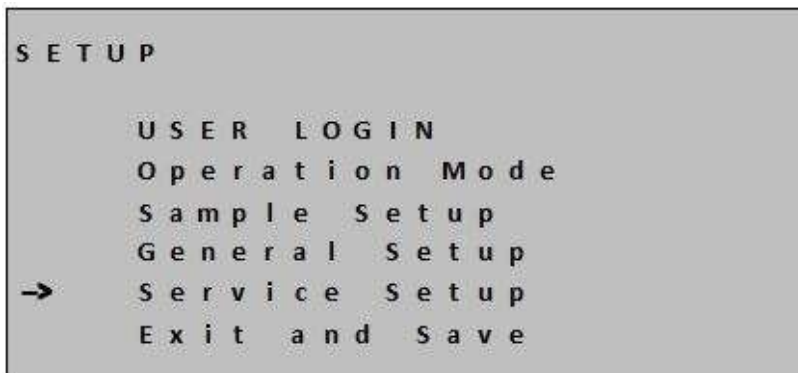

3.3.1 User Login

NOTE:

User Login is disabled by default which means user has access to all menu functions. To enable User Login, go to Service Setup > Resets > Tech User Login. A 4 digit login code will be needed to enable the Login. The unit comes from the factory with a default code of “1234” which can be changed once the Login is enabled. Be sure to record this code in a secure place. If the code is forgotten, contact the factory for assistance.

If the User Login is enabled, then any user who doesn't have the login code will only be able to perform two functions:

1. Change Trend Graph mapping.
2. Turn on the Output Hold so cleaning can be performed without disrupting the output signals (4-20mA, Modbus, Data Log).

3.3.2 Operation Mode

Select between Online Mode and Grab Sampler Mode.

3.3.3 *Sample Setup*

From the top Setup menu move the arrow down to “Sample Setup” and press **Enter**. You should see the below screen when in Online mode. **Go to section 4.0 for Grab Sample Mode “Sample Setup” menu description.**

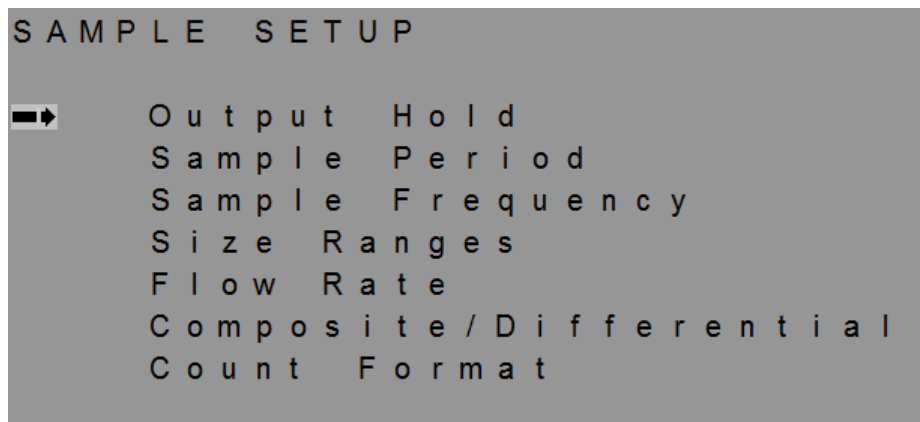

3.3.3.1 *Output Hold*

The Output Hold allows the user to temporarily hold the measurement result being sent to the analog outputs and digital communications (i.e. MODBUS) for a user defined length of time (up to 60 minutes). This function prevents data excursions to the SCADA/DCS while the unit is being serviced. The display on the PC5000 will display “Holding” in the bottom left hand corner as long as the Output Hold is active. The PC5000 will still perform measurements and update the local display while Output Hold is active.

3.3.3.2 *Sample Period – Online Mode Only*

Sample Period is the number of seconds over which a measurement is made. Default value is 15 seconds. The range of the Sample Period is from 4 to 998 seconds.

3.3.3.3 *Sample Frequency – Online Mode Only*

Sample Frequency is the number of seconds between measurements. Default value is 60 seconds. The range of the Sample Frequency is from 5 to 999 seconds. The Sample Frequency must be greater than the Sample Period.

3.3.3.4 *Size Ranges*

The Size Ranges menu allows the user to establish the number of bins to be measured as well as the size ranges associated with those Bins. Up to 8 Bins can be established. The sizes used for each Bin must fall between 2 and 100 μm . When in Composite mode, the sizes need to be in sequence, smallest to largest and cannot overlap. The default size for each bin is shown below.

```
2 - 5   u m
5 - 1 0   u m
1 0 - 1 5   u m
1 5 - 2 5   u m
2 5 - 5 0   u m
5 0 - 1 0 0   u m
> 1 0 0   u m
```

When entering the size settings, it is not necessary to use all 8 size Bins. Entering a value of 0 will turn the Bin(s) off. The default setting for Bin 7 and Bin 8 is 0, which is why there are only 6 Size Ranges active (not counting the 'greater than' range) when the unit is received from the factory.

3.3.3.5 Flow Rate

If necessary, the Flow Rate value can be changed from the factory default setting of 75 ml/min to match the actual flow rate through the sensor (e.g. 60 ml/min) in order to achieve accurate count/ml or count/100ml readings.

NOTE:

Particle sizing may not be accurate if the unit has not been calibrated at that flow rate being used. It is recommended to leave the Flow Rate at 75 ml/min unless changes to this setting have been previously discussed with the factory

3.3.3.6 Composite or Differential – Online Mode Only

This allows the user to choose between using Composite or Differential Size Range settings. Composite size ranges (like what is shown on previous page) cannot overlap. In Composite mode, if 5 micron is the "To" value in Bin 1 then it must also be the "From" value in Bin 2. In Differential mode, the bins can overlap. Below is an example of how the Differential Bins could be setup.

```
2 - 1 0 0   u m       -   7 3 7   / m l
5 - 1 0 0   u m       -   8 2     / m l
1 0 - 1 0 0   u m     -   3       / m l
1 5 - 1 0 0   u m     -   1       / m l
2 5 - 1 0 0   u m     -   0       / m l
5 0 - 1 0 0   u m     -   0       / m l

                               T i m e   1 6 : 2 0
```

3.3.3.7 Count Format

Allows user to choose between Counts per ml (default setting), Counts per 100 ml, and Raw Counts.

3.3.4 General Setup

From the top Setup menu move the arrow down to "General Setup" and press **Enter**. You should see the below screen.

```
GENERAL SETUP
- - - - -
-> Trend Settings
   Display Contrast
   Time and Date
   Outputs & Alarms
   Communications Setup
   Log Frequency
```

3.3.4.1 Trend Settings

The Trend Settings menu allows the user to map one of several variables to the Trend Graph. These include Total Counts, all Bin counts, Cell Condition, Laser Condition, and Analog Inputs. Upon selecting which variable to map to the graph, the menu prompts the user to select the max scaling for the graph. The range of the Trend Maximum scaling is from 1 to 65000. The default value is 200 counts.

3.3.4.2 Display Contrast

Allows the user to adjust the LCD contrast settings for best viewing performance.

3.3.4.3 Time and Date

Allows the user to set the time and date settings on the PC5000. Note: An internal battery keeps the internal clock running while the unit is turned off. The instrument will not automatically adjust for daylight savings time.

3.3.4.4 Outputs & Alarms

Under the Outputs & Alarms menu the user can Map and Scale the 4-20mA Outputs.

The Alarm Setup allows the user to Map up to two Alarms and set the Alarm Threshold. Note: The Alarm settings also control the optional alarm relays. Alarm 1 controls Relay 1 and Alarm 2 controls Relay 2.

The mapping options for the Outputs and Alarms includes Total Counts, all Bin counts, Cell Condition, Laser Condition, and Analog Inputs.

Setup for optional Analog Inputs is also accessed through this menu via the Input Type selection. It is necessary to identify each input channel as either 0 – 10 VDC, 0 – 5 VDC or 0 – 20 mA. The 0 – 20 mA option is also used for 4 – 20 mA signals. Jumpers on the analog input board must be configured to match the selected input type. See Figure 14.

3.3.4.5 Communications Setup

Under the Communications Setup menu the user can set the address of the PC5000, select Language options, choose the communication type (e.g. Standard Serial, RTU, TCP), set the Baud Rate, and enter the Network settings if the optional MODBUS TCP communications are being utilized.

Note: For Serial RS485 Communications, the default address is 1 and the range is from 1 to 255. Communication settings are by default 9600 baud, 1 stop bit, and no parity bit. The PC5000 can handle a baud rate up to 56K.

Note: For Ethernet Communications, the default settings are as follows:

IP Address: 192.168.1.1

Gateway Address: 192.168.1.1

Subnet Mask: 255.255.255.0

Note: The instrument will not communicate when a menu screen is active. Communications will resume when the menu is exited.

3.3.4.6 Log Frequency

This menu allows the user to selecting how often the data log and graph are updated with new data. Log Frequency is in minutes and the range is from 0 to 255 minutes. The default Log Frequency is 0 minutes. With the setting of 0 minutes, the data log and graph will be updated with each measurement taken.

4.0 PARTICLE COUNTER OPERATION-GRAB SAMPLER MODE

Note: Most of the menu settings available while in Grab Sampler mode are the same as those in Online mode and will not be duplicated in this section. If a menu feature does not appear in the following section, refer to Section 3 for a description of that feature.

Grab Sampler Keywords:

Sample – A volume of liquid to be analyzed by the particle counter. The PC5000 can store test data for over 200 individual samples before the data must be downloaded or overwritten.

Run – A single test on a given sample producing particle count data corresponding to the programmed settings. The PC5000 can be configured to perform as many as 99 Runs on one Sample.

Run Volume – The amount of Sample to be analyzed on each Run, in milli-liters.

Purge Volume – The amount of Sample that will be drawn through the sensor prior to analysis, in milli-liters.

4.1 Sample Setup

From the main menu, move the arrow down to “Sample Setup” and press **Enter**. You should see the below screen.

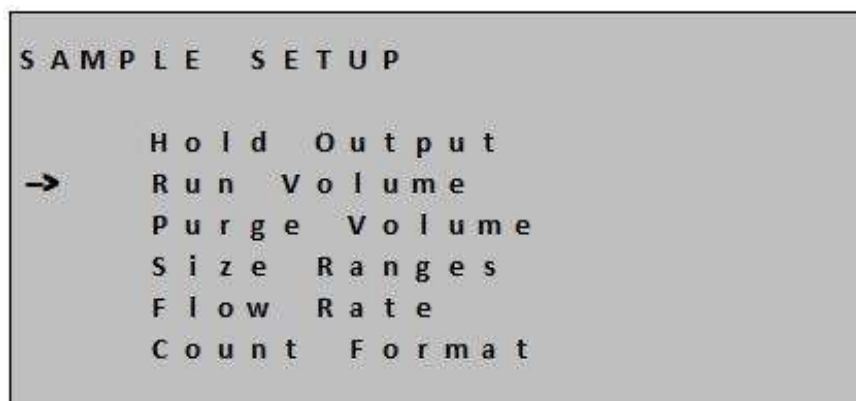

4.1.1 Hold Output

See Section 3.3.2.1

4.1.2 Run Volume

The amount of sample that is to be analyzed on each Run. After setting the Run Volume you will be prompted to set the number of runs to be performed on that sample. Each run follows immediately after the previous run so you must ensure there is enough sample liquid to perform the programmed number of runs at the programmed volume. For example, a sample set for a 100 ml Purge Volume, 20 ml Run Volume, and 10 Runs will require 300 ml of sample liquid to complete.

4.1.3 *Purge Volume*

In order to ensure that the sample liquid has reached the sensor and all air has been removed from the system through to drain, a Purge Volume is set. This volume should be adequate to ensure that the sample fluid is filling all tubing at least to the pump outlet prior to the start of particle count analysis.

4.1.4 *Size Ranges*

See Section 3.3.2.4

4.1.5 *Flow Rate*

See Section 3.3.2.5

4.1.6 *Count Format*

See Section 3.3.2.7

NOTE:

When exiting the Menu, it is necessary to select “**Exit and Save**” in order to store any changes to permanent memory. Alternatively, if exit the menu by pressing the Menu button, the changes will be saved to temporary memory only and changes to settings will be lost if the power is cycled off and on.

If changes were made to the settings that you do not wish to keep, simply exit out of the menu using the Menu button (do not perform an “Exit and Save”) and then turn the unit off and then back on. This will erase any and all changes made to the menu since the last time an “Exit and Save” was

4.2 *Grab Sampler Operation*

4.2.1 *Sample Analysis*

When the PC5000 is in Grab Sampler mode, the main display will indicate similar to that shown below. Sample # and settings may vary.

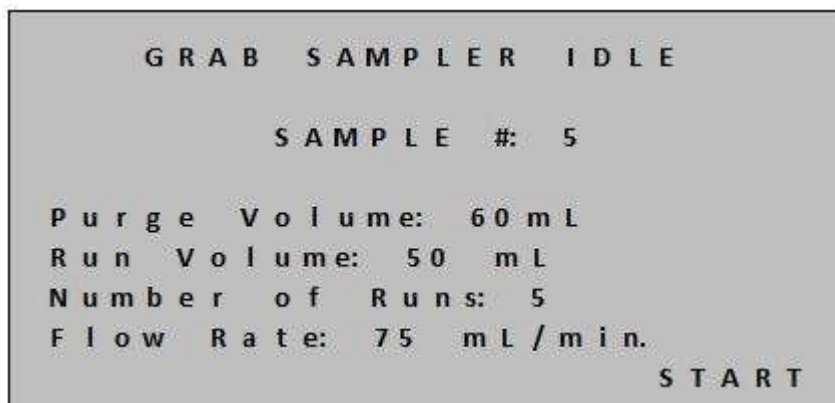

If it is necessary to change any of the settings, press the **Menu** button and refer to Section 4.1 To begin sample analysis, press the **Start** button. The PC5000 will begin analysis and a screen similar to the one following should appear.

```

GRAB SAMPLER PURGING

SAMPLE #: 5

Verify flow rate
is 75 mL/min.

STOP

```

Pressing the **Stop** button at this point will cancel the current analysis and return to the main screen. Once the Purge Volume has passed through the sensor, particle count analysis will begin and the screen will appear similar to that below, with currently programmed size ranges being displayed. The 2/5 indication displayed in the lower right corner in this case shows that the instrument has completed 2 of the 5 programmed Runs on the present Sample. Also note that the instrument Cell % is displayed. If this value is below 90%, we recommend stopping the analysis and cleaning the sensor before continuing. (See Section 5.3)

```

2 - 5           - 142 / mL
5 - 10          - 27  / mL
10 - 15         - 5   / mL
15 - 25         - 1   / mL
25 - 50         - 0   / mL
> 50           - 0   / mL

Cell 99%      SAMPLING 2 / 5

```

Once all programmed runs for the present sample have completed, or if the **Stop** button is pressed after at least one run has completed but prior to completion of all runs, the following screen will appear.

```

SAMPLE #: 5
Run : 5 of 5

COMPLETED

Press < or > To Review

ENTER - To Save
MENU  - To Discard

```

You may use the left and right arrow buttons to review each run of the current sample. In order to save the sample analysis in memory for future download, press the **Enter** button. If you wish to discard the sample analysis, press the **Menu** button. Note that the data will only be saved or discarded when the **Enter** or **Menu** button is pressed while the above screen is displayed. Pressing either button while in one of the data review screens will just return you to the above screen. Once the data has been either saved

Setup Wizard

From the PC5000 Export tab, click the Setup Wizard to learn how to use the software with the PC5000 grab sampler.

Connect the USB Communication Cable

Turn off the PC5000 Grab Sampler and connect a standard USB Cable to the USB connector on the side of the unit (See Figure 3). Connect the other end of the cable to the computer.

Wait for the computer to find and install the driver for the USB cable. When complete a new COM Port should be available for use. Use the next step to determine if the driver was installed correctly.

Find COM Port

Open the Windows Device Manager. In Windows 7 the Device Manager can be opened from the Control Panel. It can also be opened by clicking *Edit..Open Device Manager* from within the Grabbit software (see image below).

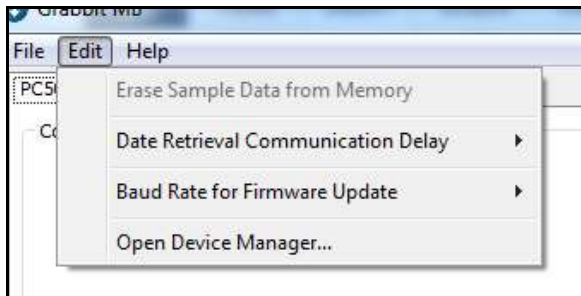

Find the *Ports (COM & LPT)* section of the Device Manager. The entry labeled **USB Serial Port** should be visible (see the image below).

If not, the driver included with the installation disk may need to be installed. To install, turn off the unit and then run the driver file (*C:\Program Files (x86)\Chemtrac\Grabbit MB\USB Driver\CDM v2.10.00 WHQL Certified.exe*). Turn the device on with the USB cable connected to see if the driver loads successfully.

Once found, make note of the COM Port following the *USB Serial Port* entry. In the example below the COM Port is COM17.

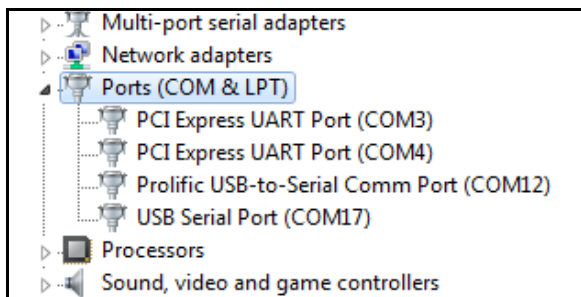

Download the Data

Select the COM Port that has been assigned to the USB Cable. In the example below the COM Port is COM17. Click the connect button (next to COM Port) to open the port. Use the status view in the lower right corner to verify that a connection has been established (see image below).

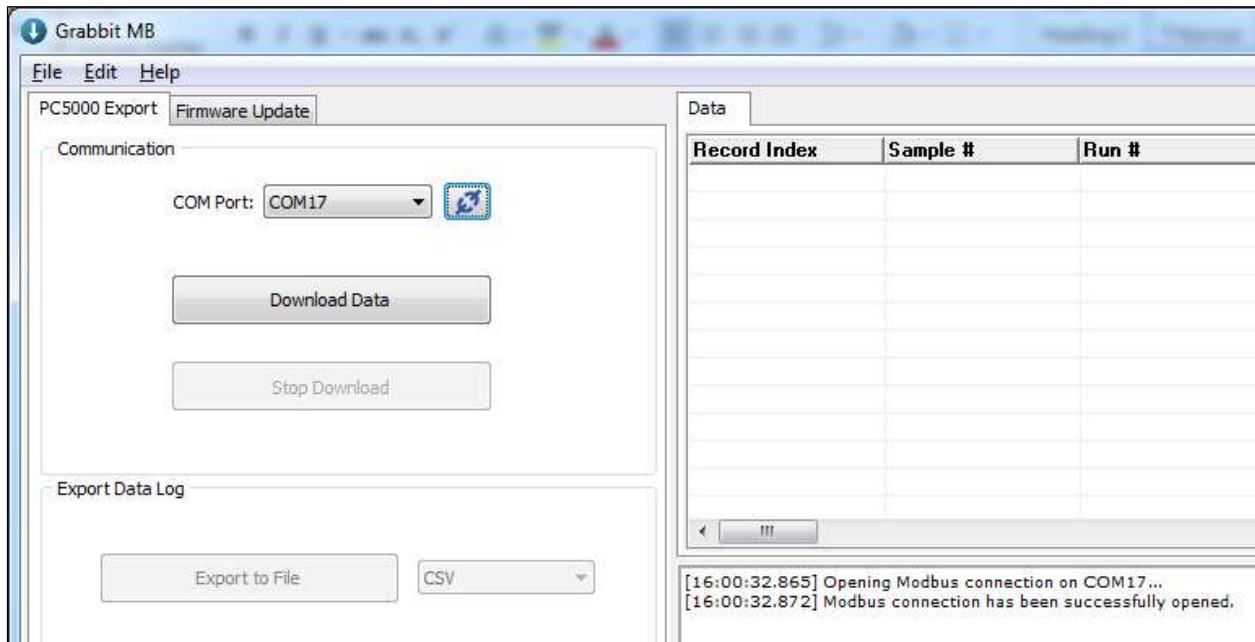

Click the *Download Data* button to start the download. An estimated completion time and progress bar are available to follow the progress.

Try running the download a second time if errors are encountered.

Use the *Stop Download* button to halt the process.

Erase Sample Data from Memory

If the download completed successfully the user will be asked to erase the data memory from the device. Click YES to erase ALL of the sample data that has been stored in the device.

*** Note that the data will be permanently removed from the devices memory. It is not retrievable once removed.*

The user can also erase the memory by clicking *Edit..Erase Sample Data from Memory* from the file menu.

Export the Data

Once the download is finished, select the desired export file type (CSV, XLS, or HTML) and then press the Export to File Button.

Select the desired output location and filename from the Save Dialog window, and then press the Save button to export the file (see image below).

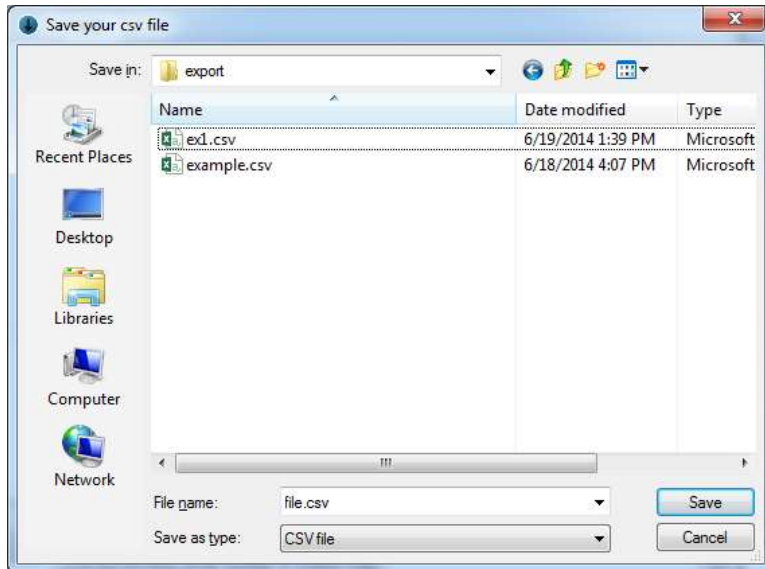

4.2.3 Erasing Grab Sampler Data via Service Menu

Once all necessary data has been downloaded from the PC5000 you may delete the data from memory, resetting the sample number to 1. If the data was not erased via software following the download, it can be erased via the main setup menu by selecting Service Setup as shown below.

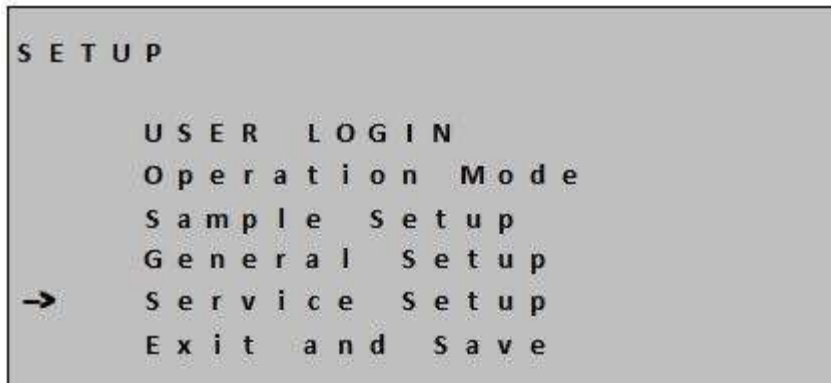

From the Service Setup menu, select Resets as shown below.

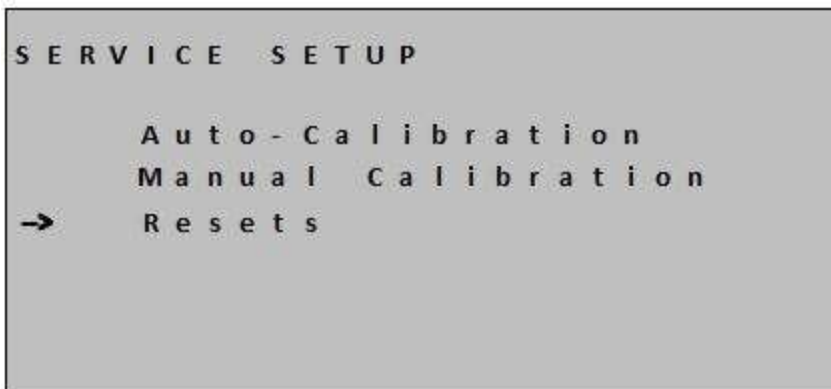

In the Resets menu, select Erase Grab Memory. On the next screen, select Yes and press the **Enter** button.

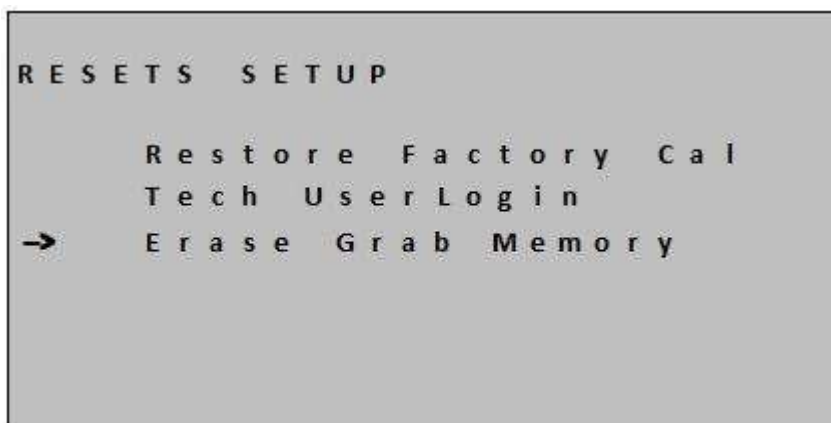

When the PC5000 has finished erasing the Grab memory the display will return as shown above. Press the Menu key repeatedly to exit the menu. It is not necessary to perform an “Exit and Save” of a memory erase. The main screen should now indicate that is prepared for Sample #1.

5.0 SERVICE AND ROUTINE MAINTENANCE

5.1.1 *Service Setup*

From the top Setup menu move the arrow down to “Service Setup” and press **Enter**. You should see the below screen.

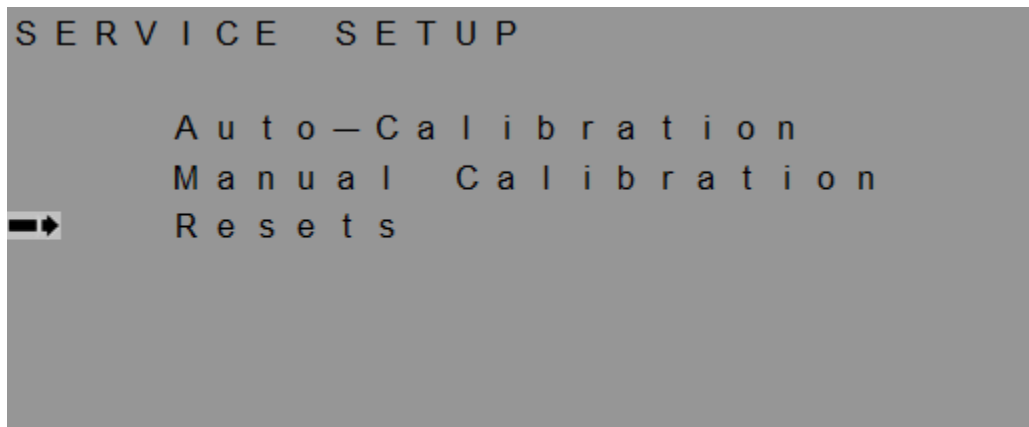

5.1.1.1 *Auto-Calibration & Manual Calibration*

The settings under this menu are used to adjust the calibration of the PC5000. These menus should not be accessed unless the person accessing the menu has thoroughly reviewed the calibration procedure provided by Chemtrac, Inc. The calibration procedure is a separate document from this manual and can be obtained by contacting Chemtrac at 770-449-6233 or via email at Chemtrac@chemtrac.com. Please provide your full contact info as well as your instrument’s version and serial number.

5.1.1.1.1 *4-20mA Output Calibration*

If the PC5000 is equipped with the optional 4-20mA Output Board, the 4-20 mA Outputs can be set to 4 or 20 mA by accessing the **Output Adjust** menu under the Manual Calibration menu.

5.1.1.2 *Resets*

Under the Resets menu there are three selections.

Restore Factory Cal – This will take all the instrument settings, including the calibration settings, back to what they were when the unit shipped from the factory. This is provided to allow the user to return back to factory settings in the event the unit is no longer operating properly and it is suspected that changes to critical instrument settings may have been made that are affecting the unit’s operation.

Tech User Login – Enabling the Tech User Login will limit normal users to only being able to do two things:

1. Enable the “Output Hold” so they can service the sensor without disrupting the data being sent to the SCADA/DCS.
2. Change the scaling for the Trend on the front panel display.

When enabling the Tech User Login, the user will be required to enter the old password. On a new unit the password is **1234**. Once the correct “old” password has been entered, the user is allowed to Enable the Tech User Login and create a new password. Be sure to record this password in a secure location. If the password is lost, contact Chemtrac for a password reset.

If in Online mode, Erase Data Memory will appear. In Grab Sampler mode, Erase Grab Memory will appear (See Section 4.4)

Erase Data Memory – This will clear the PC5000's data log. Once data is erased, it cannot be retrieved. If you wish to retain the logged data, be sure to download the log using the TracData download software prior to erasing. This feature will only erase the data stored while in Online mode. The PC5000 must be in Grab Sampler mode to erase the Grab Sampler memory.

Note: It does require Level 2 Tech User access to erase memory. It is recommended to enable Tech User Login in order to prevent unauthorized erasing of the data log

5.2 RS-485/USB COMMUNICATION AND POWER INDICATORS

The PC5000 comes equipped with three status LED's. One red LED to indicate power and a yellow LED for TX and a green LED for RX to indicate the unit is properly communicating with the host computer. The red power LED in combination with the illuminated LCD lets the user know the unit has the appropriate power to function properly. **Note:** The yellow TX LED will blink once on power up.

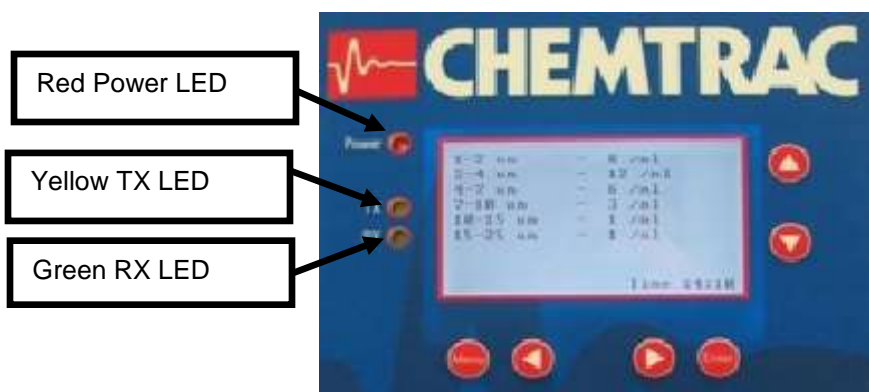

Status LEDs

Contact Chemtrac if the LED's do not appear to be functioning properly and communication cannot be established with the host computer.

5.3 ROUTINE MAINTENANCE

It is important that a consistent flow rate be maintained since the data produced by the particle counter is based on the sample volume (particles per milliliter). As the tubing and flow cell become dirty, flow will be restricted. Therefore it is necessary that a proper maintenance schedule be followed to ensure the flow rate is not adversely impacted from fouling.

If adequate sample pressure is available, the constant head flow control weir will maintain an accurate flow rate through the sensor. Flow problems will only be caused by fouling of the flow cell and fouling of the tubing and barb fittings. Obviously, the more turbid the sample, the more likely clogging / fouling will occur. If raw water is being sampled, it is recommended that a small 40 mesh strainer be placed in line before the sensor to catch debris.

Routine cleaning of the flow cell should be performed on a regular basis. How often the flow cell should be cleaned will vary depending on water quality. The cell condition is monitored by the particle counter electronics, and can be used as an indication of when cleaning is necessary. A drop in the cell condition

to 85% (or 10 to 15% from previous reading obtained after cleaning) indicates that cleaning should be performed.

Any standard laboratory cleaner can be used to clean the flow cell. If iron or manganese buildup is a problem, vinegar, CLR, or another slightly acidic liquid, can be used. The cleaner can be flushed through the flow cell, or applied using the cleaning brush. The sapphire window material and the external flow cell design make brush cleaning a safe and effective method for removing tough contaminants.

NOTE

Prior to connecting the sensor, the sample line should be flushed thoroughly. Failure to do this is a common cause of clogged sensors.

Several methods may be used to clear a clogged flow cell. One of the most effective tools is a small can of compressed air (available at Radio Shack or most hardware stores). Remove the tubing from both sides of the flow cell and blow the air through the flow cell from the top of the flow cell (opposite direction from the flow). If compressed air is not available run the liquid sample in from the top of the flow cell and increase the flow rate. The flow cell windows are sapphire, which is scratch resistant, but it is not recommended that pieces of wire or other objects be used to clear clogs. Once the clog is removed, a light can be shined through the sensor to allow visual inspection. The flow cell opening is large enough to see through when clear.

NOTE

The particle counter can still count particles with a dirty flow cell, but the accuracy may be diminished.

5.3.1 *Non-brush Cleaning*

Fill a large syringe with cleaner (diluted to manufacturer's recommendation) and attach it to the top flow cell barb with a short piece of tubing (See Figure 14). Squeeze the syringe to introduce the cleaner into the sensor and let it sit for a few minutes and then inject some more and let that stand a few more minutes. Finally, force the remaining cleaner rapidly through the flow cell. The rapid flow should remove most buildup that has occurred in the sensor and bring the cell condition back up to an acceptable level. Non-brush cleaning is not a replacement for occasionally cleaning with a brush, but it useful when you don't have a brush on hand.

5.3.2 *Brush Cleaning*

Remove the tubing from the sensor's fittings. Insert brush from top of sensor until it rests snugly in the flow cell (See Figure 14). Move the brush in and out of the flow cell using short strokes. Brush again from the other side of the sensor.



Figure 14 Sensor Cleaning Methods

NOTE

The small size of the brush makes it easy to bend or damage. Do not force the brush into the flow cell. It should fit into the flow cell with light pressure.

Once cleaning has been performed, reattach flow lines and allow a minute or so for the flow cell to flush out. Verify that the cell condition indicator is back in the 90% range. If it is not, repeat the procedure.

NOTE

The cell condition indicator is not valid if the sensor is not full of water and clear of air bubbles.

5.3.3 Replacing Tubing

As the tubing becomes dirty, it will restrict flow through the sensor and can also contribute to higher counts (especially if the tubing is disturbed), so sensor tubing should be replaced as it becomes visibly fouled. It is not necessary to replace the Flow Control Weir drain tubing or the drain tubing on the bottom of the Drain Cup. Weir Inlet tubing should be replaced on occasion to help reduce the potential for vibration or any kind of movement on the tubing to release particles. Ensure that sample flow has been stopped, any pressure build up has dissipated and liquid has drained prior to disconnecting any tubing. It is reasonable to expect some liquid spillage when disconnecting tubing so be certain that no sensitive electronics or live circuits are exposed.

5.3.4 Battery Replacement

In the event of a loss of power, the PC5000 utilizes a battery backup for the sole purpose of maintaining the real time clock. Under normal operation, the battery should last several years before requiring replacement. The recommended battery is a lithium coin, 3 volt, 23mm, CR2330. When replacing the battery, be certain to install the battery with the proper polarity. The positive side of the battery should be facing left when inserted. See Figure 14.

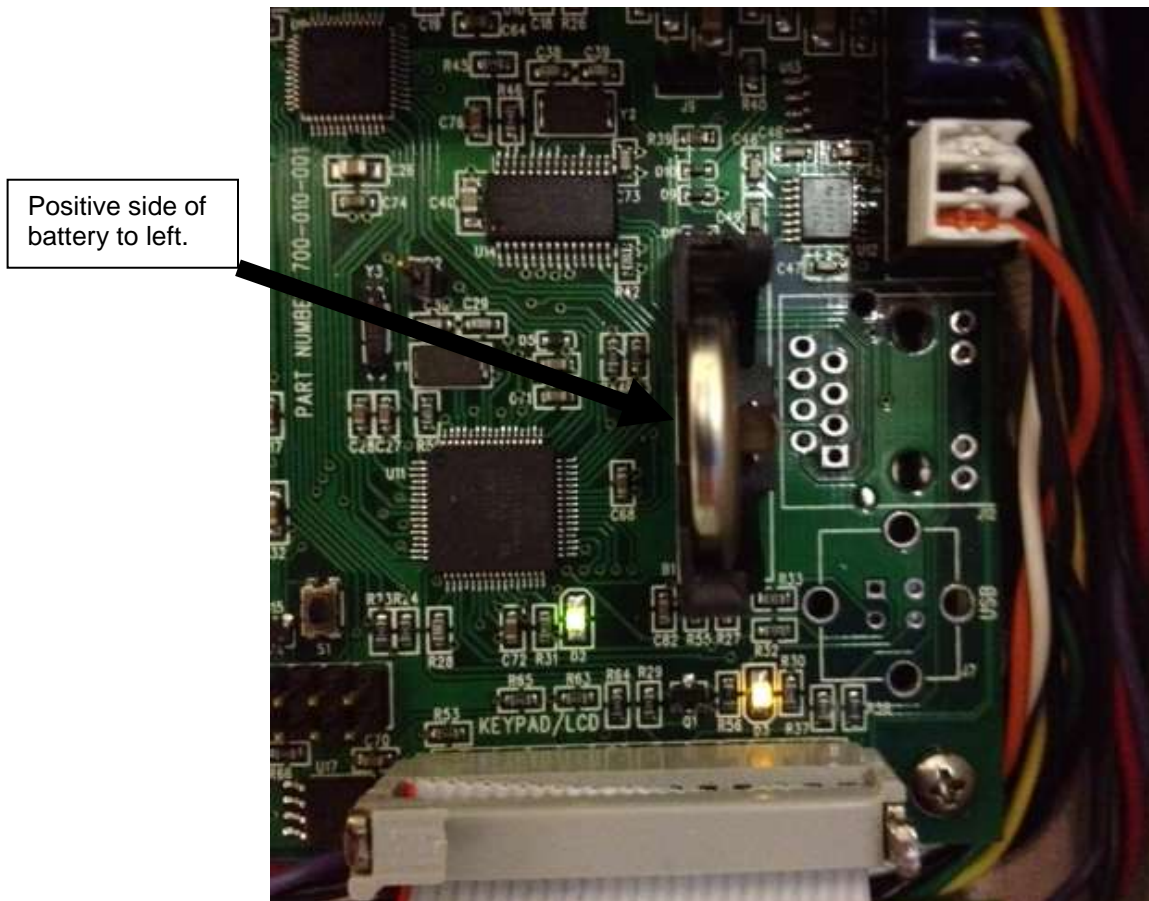

Figure 15 Battery Installation

6.0 RECOMMENDED SPARE PARTS LIST

<u>Part #</u>	<u>Description</u>
11420	Sensor Sample Tubing*
11152	Pump Filter (Protects pumps from plugging)**
11425	Weir Inlet & Drain Cup Tubing (if Weir is utilized)*
34400	Sensor Cleaning Brush

*Tubing can also be ordered from Cole Parmer using the below product numbers:

PN: EW-6409-16 (Sensor Sample Tubing)

PN: EW-06409-15 (Weir Inlet and Drain Cup Tubing)

** The Pump Filter will last a long time if back flushed routinely to remove solids and periodically cleaned. To clean, remove filter and inject bleach solution or diluted acid to help remove any organic or mineral buildup. The filter is made of PEEK plastic and holds up well to cleaning. Having a spare allows the user to swap out the filter for cleaning (if necessary).

6.1 ORDERING SPARE PARTS

To place an order for spare parts you may either call, e-mail, or fax Chemtrac Inc. directly or contact your local distributor or representative. The following information should be included in the your request; model number and serial number of Particle Counter, part number(s), qty, and description of parts needed. Pricing and availability are available upon request.

Normal lead-time in stock parts is 1 to 2 days.

Chemtrac Inc.
6991 Peachtree Industrial Blvd. Building 600
Norcross GA 30092

Ph: Inside US 1-800-442-8722, 770-449-6233

Fax: 770-447-0889

Email: chemtrac@chemtrac.com

www.chemtrac.com



Distributed by:

Kenelec Scientific Pty Ltd
1300 73 22 33
sales@kenelec.com.au
www.kenelec.com.au