

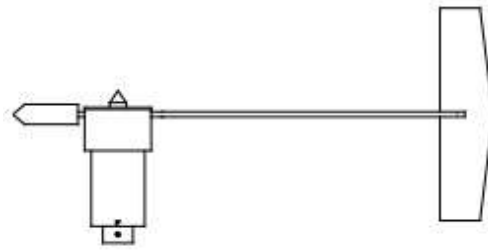

“Relied on Worldwide in the Most Extreme Conditions”



**TD-106-5D
TD-106-5D-A
Wind Direction Sensor
User’s Manual**



Model TD-106-5D Wind Direction Sensor

DESCRIPTION

The Texas Electronics, Inc. TD-106-5D Wind Direction Sensor is a mechanical style wind meter that measures the horizontal wind azimuth. This unit combines small physical size with superior bearings to meet the EPA's Prevention of Significant Deterioration (PSD) requirements.

The TD-106-5D Wind Direction Sensor is a freestanding device for measuring the direction of wind. The sensor consists of a vane and counterweight assembly, which is mechanically coupled to a potentiometer (variable resistor). As the vane rotates in the wind, the potentiometer changes resistance proportionally to the direction of wind.

SPECIFICATIONS

	<u>TD-106-5D</u>	<u>TD-106-5D-A</u>
Operating Range:	0-360° mechanical	0-360° mechanical
Signal Presentation:	10000 ohm potentiometer	4-20 mA
	0-357° electrical	0-355° electrical
	3 VDC excitation minimum	10-30 VDC
Performance:		
Accuracy:	+/- 3.0°	+/- 3.0°
Potentiometer linearity:	+/- 0.5%	+/- 0.5%
Starting Threshold:	1.1 mph (0.5 m/s)	1.1 mph (0.5 m/s)
Damping Ratio:	0.4 to 0.6	0.4 to 0.6
Damped Wavelength:	11.5' (3.5 m)	11.5' (3.5 m)
Delay Distance:	2.6' (0.8 m)	2.6' (0.8 m)
Resolution:	1°	1°
Environmental:		
Operational Envelope:	0-135 mph (0 to 60 m/s)	0-135 mph (0 to 60 m/s)
Temperature:	-40 to 160° F (-40 to 70° C)	-40 to 160°F (-40 to 70°C)
Relative Humidity:	0-100%	0 to 100%
Physical:		
Vane Overall Length:	18.8" (48 cm)	18.8" (48 cm)
Overall Height:	8.75" (22 cm)	8.75" (22 cm)
Weight:	1.3 lbs (0.6 kg) less cable	1.3 lbs. (0.6 kg) less cable
Bearings:	APEC 3 or better	
Mounting Pole:	0.75" O.D. (1.9 cm)	0.75" O.D. (1.9 cm)
Cable:	60', 22 gauge 3 conductor	60', 22 gauge 3 conductor
Warranty:	3 years	3 years

FEATURES & BENEFITS

- Superior low starting threshold
- Long life hybrid single wiper potentiometer
- No plastic parts for extremely long life
- Precision stainless steel bearings for stability and repeatability
- Crossarm included with purchase of matching wind speed sensor
- Easy installation and maintenance
- Over 25 years in production
- Lightweight and rugged anodized aluminum exterior

INSTALLATION & MAINTENANCE

Installation consists of attaching the unit to a mast via the supplied mounting pole. If a crossarm is used, the entire unit can be bolted to a mast or attached via U-bolts.

The sensor is dynamically calibrated at the factory and due to the nature of its operation should not require field calibration. Calibration is a matter of proper orientation during installation. A magnetic compass is recommended for proper orientation. Field maintenance should include occasional cleaning of the vane assembly and inspection of the internal mechanism to make sure it is free from insects and debris. In some applications users may need to occasionally verify and document sensor accuracy with a calibration dial/ vane. Possible bearing and potentiometer replacement every three to five years is recommended to maintain low starting threshold.

ORDERING INFORMATION

Model #	Description
TD-106-5D	Wind Direction Sensor, Medium Industrial
TD-106-5D-A	Wind Direction Sensor, 4-20 mA

* Sensor is designed to work with TV-110-L320 wind speed sensor.

Optional Parts / Accessories

Bearing Housing Assembly
Fin & Arm Assembly

PROPER EXPOSURE OF METEOROLOGICAL INSTRUMENTS

The following generally recognized guidelines depict ideal sensor mounting locations. These guidelines are only suggestions to aid the user in selecting optimum representative sampling locations for a particular sensor.

Reference was made to US Weather Bureau Installation criteria in preparing this data (See Reference 1).

WIND EQUIPMENT:

So far as available sites permit, wind sensors should be placed above the ground on a freely-exposed tower (20 feet or higher) and over terrain that is relatively level and free from obstructions to wind flow. When a compromise must be made, sensing units should be exposed at least 12 feet above any obstruction within 100 feet and at least as high as any obstruction within 100 to 200 feet of the wind equipment. Support towers or masts should not be of such bulk or shape as to create an appreciable obstruction to wind flow. Avoid sites where local obstructions may create up-or-down drafts, eddy currents or jet-flow effects. When sensors are roof-mounted, they should be installed at least 10 feet (or more) from the roof surface, depending upon the particular installation site. Turbulence and other local effects can be reduced somewhat by mounting sensors on the upwind end of the building (the end of the building exposed to the most common local prevailing winds). Horizontal-mount booms that extend from existing towers should be fabricated so that sensors will extend a distance of 5 to 10 feet from the tower assembly (dependent on tower thickness).

Wind direction sensors are oriented upon installation in reference to either true north or magnetic north. True north is obtained by applying a local magnetic variation correction factor to a magnetic north compass indication (magnetic variation for a particular locality is obtainable from the nearest Weather Bureau Branch Office). Indicator readings for a true north sensor orientation will then be in terms of true geographic compass points. All U.S. Weather Bureau surface wind data used for observational network reporting purposes and general public use is given in reference to this true north format. Indicator readings for a magnetic north sensor orientation will be in terms of actual readings as would be obtained from directly viewing a magnetic compass instrument. Wind direction data at Federal Aviation Agency and other aircraft reporting facilities (for direct control tower-to-pilot utilization) is always made in reference to this magnetic north format.

WIRING DIAGRAM

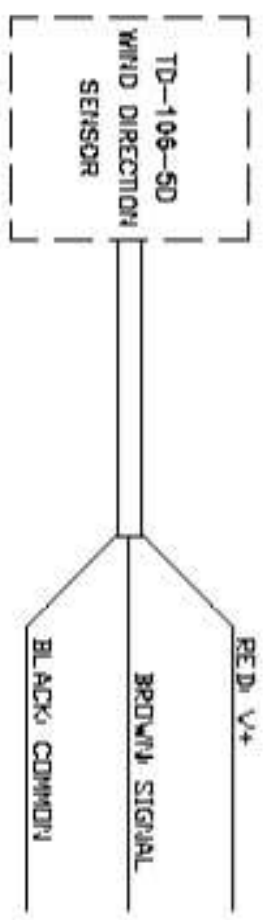

TYPICAL RANGE
 0-360° Mech., 0-357° Elect.

OUTPUT
 10K OHM POTENTIOMETER

Texas Electronics, Inc.			
The Gold Standard in Weather Instrumentation Since 1957			
			
TITLE			
TD-106 WIND DIRECTION WIRING DIAGRAM			
SIZE	FROM ID.	DWG. NO.	REV.
A		3016	A
ED. NO.		SHEET	1-1

WIRING DIAGRAM

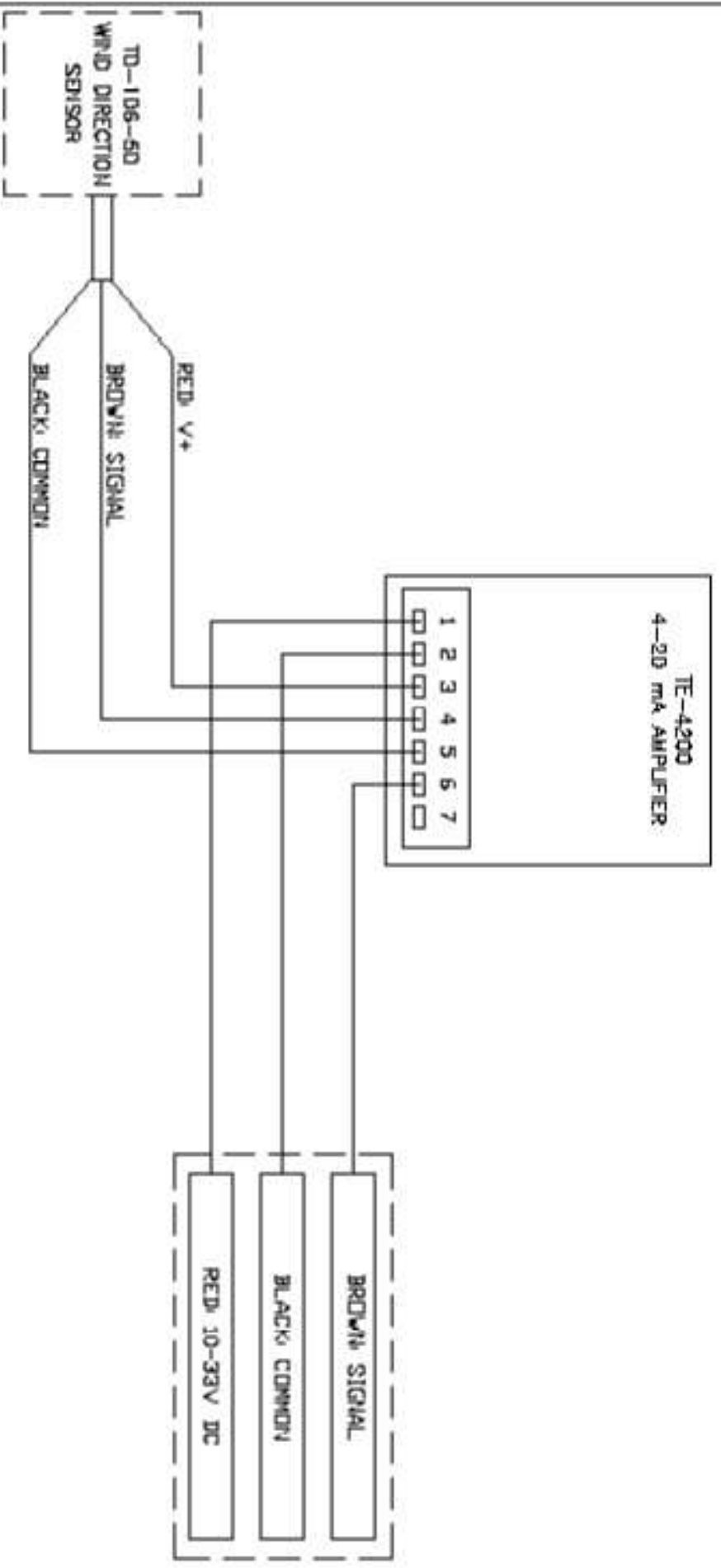

TYPICAL RANGE
 0-355' ELECTRICAL, 0-360' MECH.

OUTPUT
 4 to 20 mA

Texas Electronics, Inc.			
The Gold Standard in Weather Instrumentation Since 1957			
			
TITLE		TD-106A WIND DIRECTION	
SIZE	PDSW NO.	DWG NO.	REV
A		3015	A
SCALE		SHEET	1-1

WIRING DIAGRAM

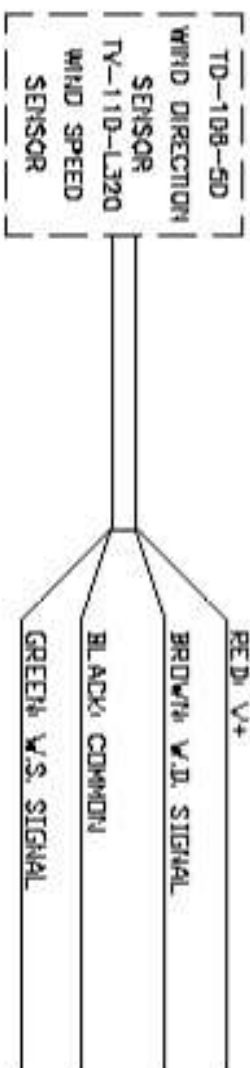

TYPICAL RANGE

WIND DIRECTION: 0-360° Mech., 0-357° Elect.

WIND SPEED: 0-100 MPH

OUTPUT

WIND DIRECTION: 10K OHM POTENTIOMETER

WIND SPEED: 1000 RPM = 100 MPH = 20k pulses/min

Texas Electronics, Inc.
 The Gold Standard in Weather Instrumentation Since 1957



TITLE TD-106 WIND DIRECTION & TV-
 110-L320 WIND SPEED WIRING DIAGRAM

SIZE	FROM I.D.	DATE I.D.	REV
A		3014	A
SCALE		SHEET	1-1

WIRING DIAGRAM

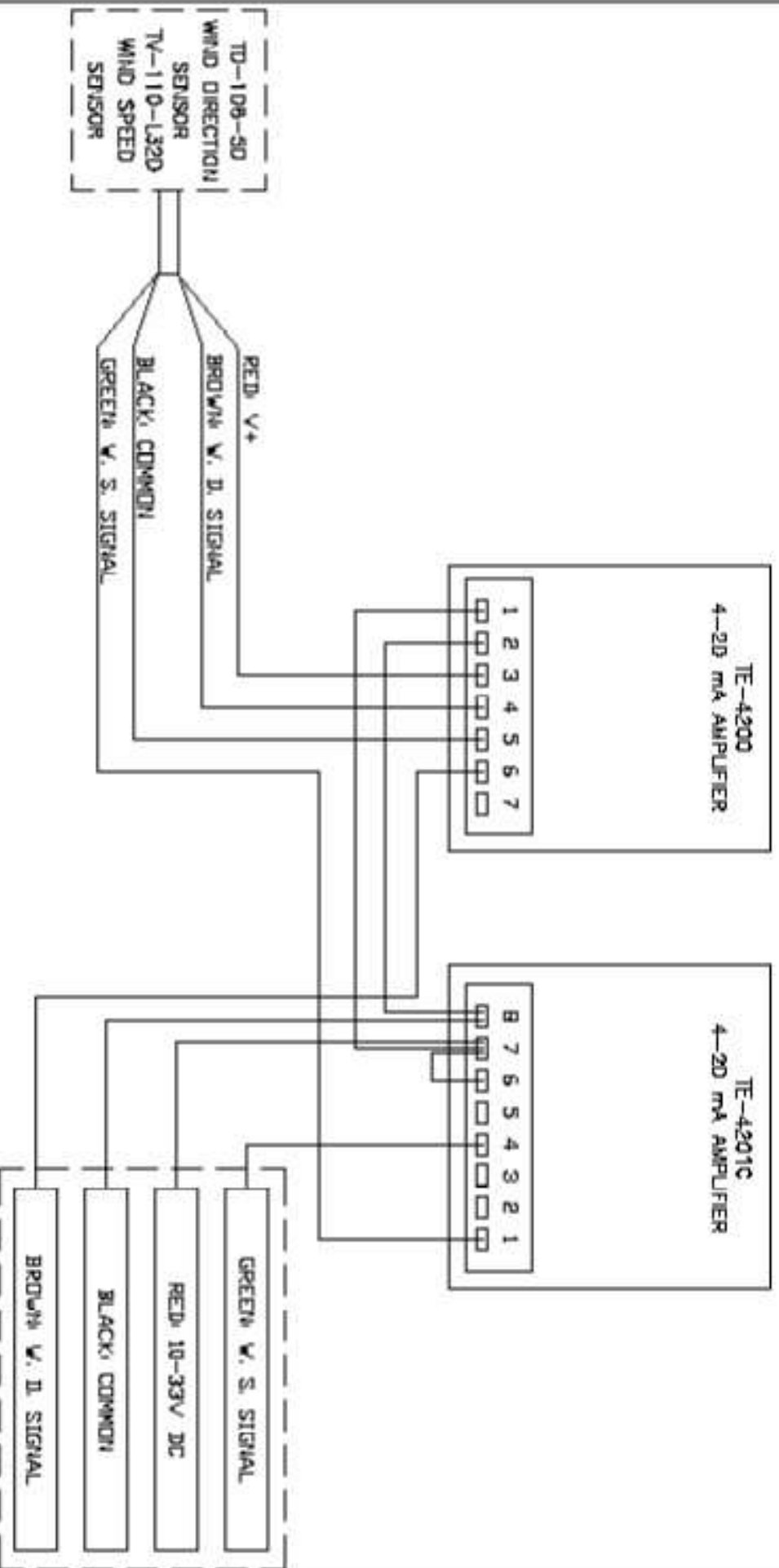

TYPICAL RANGE
WIND SPEED: 0-100 MPH
WIND DIRECTION: 0-355° ELECTRICAL, 0-360° MECH.

OUTPUT
 4 to 20 mA

Texas Electronics, Inc.
 The Gold Standard in Weather Instrumentation Since 1967

TITLE		TD-106A WIND DIRECTION & TV-110-L320A WIND SPEED	
SIZE	FORM NO.	DRG. NO.	REV.
A		3013	A
SHEET		SHEET 1-1	

Warranty

Texas Electronics, Inc. (hereafter TEI) warrants the equipment manufactured by it to be free from defects in material and workmanship. Upon return, transportation charges prepaid to TEI, within three (3) years of original shipment of sensors and one (1) year of original shipment of electronics, recorders and indicators, TEI will repair or replace, at its option, any equipment which it determines to contain defective material or workmanship, and will return said equipment to purchaser, F.O.B., TEI. Texas Electronics shall not be obligated however to repair or replace equipment which has been repaired by others, abused, improperly installed, altered or otherwise misused or damaged in any way. TEI will not be responsible for any dismantling, re-assembly, or reinstallation charges.

This warranty is in lieu of all other warranties, expressed or implied. TEI shall not be liable for any special, indirect, incidental or consequential damages claimed in connection with any rescission of this agreement by purchaser.



**kenelec
scientific**
measuring up

Distributed by:

Kenelec Scientific Pty Ltd
1300 73 22 33
sales@kenelec.com.au
www.kenelec.com.au