



Rev. C | 2019.01

**DCC** Dual Channel Controller

[www.critical-environment.com](http://www.critical-environment.com)

## TABLE OF CONTENTS

<b>1 POLICIES</b> .....	<b>5</b>
1.1 Important Note .....	5
1.2 Warranty Policy .....	5
1.3 Service Policy .....	6
1.4 Copyrights .....	6
1.5 Disclaimer .....	7
1.6 Revisions .....	7
<b>2 INTRODUCTION</b> .....	<b>8</b>
2.1 General Description .....	8
2.2 Key Features .....	8
<b>3 INSTRUMENT SPECIFICATIONS</b> .....	<b>9</b>
3.1 Technical Specifications .....	9
3.2 Enclosure Dimensions .....	11
<b>4 SENSOR SPECIFICATIONS</b> .....	<b>12</b>
4.1 List of Available Internal Sensors .....	12
4.2 List of Available ESH-A Remote Sensors .....	12
4.3 List of Available Remote 4-20 mA Transmitters (Gas Detectors) .....	13
4.4 Special Considerations for Sensors .....	13
4.5 Calibration Extending Firmware (CEF) and Sensor Aging .....	13
<b>5 FEATURES</b> .....	<b>14</b>
5.1 Front Exterior Enclosure .....	14
5.2 Interior System Layout .....	15
<b>6 INSTALLATION</b> .....	<b>16</b>
6.1 General Safety Warnings .....	16
6.2 Protection Against Electrical Risks .....	16
6.3 Protection Against Mechanical Risks .....	17
6.4 System Installation .....	17
6.4.1 Wet Environment Considerations .....	17
6.4.2 EMI and RF Interference Considerations .....	18
6.5 Sensor Mounting Heights .....	18
6.6 Standard Enclosure Mounting Components .....	19
6.6.1 Enclosure Interior Base .....	19
6.6.2 Enclosure Top .....	20
6.6.3 Enclosure Bottom .....	20
6.7 Wiring Power Connections .....	21
6.7.1 AC and DC Low Voltage Power Wiring to the DCC .....	21
6.7.2 AC Line Voltage Power Wiring to the DCC .....	22

6.8 Wiring Connections to a Remote Device .....	23
6.8.1 Wiring from DCC to a Remote 4-20 mA Transmitter or ESH-A Remote Sensor .....	23
Correct Wiring Example: DCC to Remote 4-20 mA Transmitter or Remote Sensor.....	24
6.8.2 Wiring from DCC to a Remote Strobe/Horn.....	24
6.9 Incorrect Wiring Examples (IMPORTANT) .....	24
6.10 Relay Connections.....	25
<b>7 OPERATION .....</b>	<b>25</b>
7.1 General System Operation.....	25
7.2 Display Select.....	25
7.3 Fault Detection.....	26
7.4 Jumpers .....	26
7.5 Test/Config Mode Functions.....	27
7.5.1 How to Navigate the Test/Config Menu.....	27
7.5.2 Hold Relay #.....	27
7.5.3 Disable Channel # .....	28
7.5.4 Display Mode.....	28
7.5.5 CH# Current Test.....	28
7.5.6 CH# Current Calibration.....	28
7.5.7 Output CH1 Max Follow .....	28
7.5.8 CH# Alarm# Direction .....	28
7.5.9 CH# Change 4-20 mA Output to 0-20 mA Output .....	28
7.5.10 Output CH# Fault Level .....	29
7.5.11 Relay Fault State .....	29
7.5.12 Buzzer Fault State .....	29
7.5.13 Relay Latching .....	29
7.5.14 Relay Hold Off Enable/Disable.....	29
7.5.15 Setting the Hold Off Time Relay .....	29
7.6 Audible Alarm / Buzzer Operation.....	29
7.7 Setting Buzzer ON Delay.....	30
7.8 Adjusting Alarm Set Points.....	30
7.9 Setting Relay ON / OFF Delays .....	31
7.10 Minimum Runtime.....	32
7.11 Analog Output Characteristics.....	32
<b>8 CALIBRATION.....</b>	<b>32</b>
8.1 Calibration Specifications.....	32
8.1.1 Gas.....	32
8.1.2 Regulators & Flow.....	32
8.1.3 Adapters .....	32
8.1.4 Calibration Frequency .....	33
8.1.5 Gas Testing Frequency (Bump Testing).....	33

8.1.6 Non-Intrusive Calibration with Magnetic Wand .....	33
8.2 Set the Span / Calibration Gas Level .....	33
8.3 Calibrating the Internal Sensor.....	34
8.4 Trouble Shooting Calibration .....	35
8.4.1 Calibration Adapter.....	35
8.4.2 Zero Override .....	35
8.4.3 Zero Fault.....	35
8.4.4 Zero Shift .....	35
8.4.5 Span Override .....	36
8.4.6 Span Fault.....	36
8.4.7 DEAD_FAULT.....	36
8.5 Calibrating an Oxygen Sensor .....	36
8.6 Calibrating a New Internal Sensor (Rollback) .....	36
8.7 Calibrating a Second Internal Sensor.....	37
8.8 Calibrating a Remote 4-20 mA Transmitter .....	37
8.9 Calibrating an ESH-A Remote Sensor .....	37
8.9.1 Zero and Span Calibration of a Responsive Sensor (done at the DCC) .....	37
8.9.2 Zero Calibration of a New or Replacement Sensor.....	37
<b>9 ACCESSORIES .....</b>	<b>38</b>
9.1 Splash Guard (Option -S).....	38
9.2 Calibration Adapter Clip "Cal Clip".....	38
9.3 Top Mounted Strobe (Option -L).....	38
9.4 Metal Protective Guard .....	39
9.5 Magnetic Wand.....	40
9.6 Calibration Kit .....	40
<b>10 MAINTENANCE .....</b>	<b>40</b>
<b>11 TROUBLE SHOOTING .....</b>	<b>41</b>

## 1 POLICIES

### 1.1 Important Note

Read and understand this manual prior to using this instrument. Carefully read the warranty policy, service policy, notices, disclaimers and revisions on the following pages.

This product must be installed by a qualified electrician or factory trained technician and according to instructions indicated in this manual. This instrument should be inspected and calibrated regularly by a qualified and trained technician. For more information, refer to Sections *8 Calibration* and *10 Maintenance* of this manual.

This instrument has not been designed to be intrinsically safe. For your safety, **do not** use it in classified hazardous areas (explosion-rated environments).

**INSTRUMENT SERIAL NUMBER:**

---

**PURCHASE DATE:**

---

**PURCHASED FROM:**

---

### 1.2 Warranty Policy

Critical Environment Technologies Canada Inc. (CETCI), also referred to as the manufacturer, warrants this instrument, (excluding sensors, battery packs, batteries, pumps and filters) to be free from defects in materials and workmanship for a period of **two years from the date of purchase from our facility**. The sensors have a warranty period of **one year on a pro-rated basis from the date of purchase from our facility**. If the product should become defective within this warranty period, we will repair or replace it at our discretion.

The warranty status may be affected if the instrument has not been used and maintained as per the instructions in this manual or has been abused, damaged, or modified in any way. This instrument is only to be used for purposes stated herein. The manufacturer is not liable for auxiliary interfaced equipment or consequential damage.

Due to ongoing research, development, and product testing, the manufacturer reserves the right to change specifications without notice. The information contained herein is based on data considered accurate. However, no warranty is expressed or implied regarding the accuracy of this data.

All goods must be shipped to the manufacturer by prepaid freight. All returned goods must be pre-authorized by obtaining a Returned Merchandise Authorization (RMA) number. Contact the manufacturer for a number and procedures required for product transport.

### 1.3 Service Policy

CETCI maintains an instrument service facility at the factory. Some CETCI distributors / agents may also have repair facilities; however, CETCI assumes no liability for service performed by anyone other than CETCI personnel.

Repairs are warranted for 90 days after date of shipment (sensors have individual warranties).

Should your instrument require non-warranty repair, you may contact the distributor from whom it was purchased or you may contact CETCI directly.

Prior to shipping equipment to CETCI, contact our office for a Returned Merchandise Authorization (RMA) number. All returned goods must be accompanied with an RMA number.

If CETCI is to do the repair work, you may send the instrument, prepaid, to:

**Attention: Service Department**  
**Critical Environment Technologies Canada Inc.**  
**Unit 145, 7391 Vantage Way**  
**Delta, BC, V4G 1M3**

Always include your RMA number, address, telephone number, contact name, shipping / billing information, and a description of the defect as you perceive it. You will be contacted with a cost estimate for expected repairs, prior to the performance of any service work.

For liability reasons, CETCI has a policy of performing all needed repairs to restore the instrument to full operating condition.

Pack the equipment well (in its original packing if possible), as we cannot be held responsible for any damage incurred during shipping to our facility.

### 1.4 Copyrights

This manual is subject to copyright protection; all rights are reserved. Under international and domestic copyright laws, this manual may not be copied or translated, in whole or in part, in any manner or format, without the written permission of CETCI.

All software which CETCI utilizes and / or distributes holds a proprietary interest and is also subject to copyright protection and all rights are reserved. No party may use or copy such software in any manner or format, except to the extent that CETCI grants them a license to do so. IF SOFTWARE IS BEING LOADED ONTO MORE THAN ONE COMPUTER, EXTRA SOFTWARE LICENSES MUST BE PURCHASED.

## 1.5 Disclaimer

Under no circumstances will CETCI be liable for any claims, losses or damages resulting from or arising out of the repair or modification of this equipment by a party other than CETCI service technicians, or by operation or use of the equipment other than in accordance with the printed instructions contained within this manual or if the equipment has been improperly maintained or subjected to neglect or accident. Any of the foregoing will void the warranty.

Under most local electrical codes, low voltage wires cannot be run within the same conduit as line voltage wires. It is CETCI policy that all wiring of our products meet this requirement. It is CETCI policy that all wiring be within properly grounded (earth or safety) conduit.

## 1.6 Revisions

This manual was written and published by CETCI. The manufacturer makes no warranty or representation, expressed or implied including any warranty of merchantability or fitness for purpose, with respect to this manual.

All information contained in this manual is believed to be true and accurate at the time of printing. However, as part of its continuing efforts to improve its products and their documentation, the manufacturer reserves the right to make changes at any time without notice. Revised copies of this manual can be obtained by contacting CETCI or visiting [www.critical-environment.com](http://www.critical-environment.com).

In no event will CETCI, its officers or employees be liable for any direct, special, incidental or consequential damages resulting from any defect in any manual, even if advised of the possibility of such damages. Should you detect any error or omission in this manual, please contact CETCI at the following address:

### **Critical Environment Technologies Canada Inc.**

Unit 145, 7391 Vantage Way, Delta, BC, V4G 1M3, Canada

Toll Free: +1.877.940.8741

Telephone: +1.604.940.8741

Fax: +1.604.940.8745

Email: [marketing@cetci.com](mailto:marketing@cetci.com)

Website: [www.critical-environment.com](http://www.critical-environment.com)

## 2 INTRODUCTION

### 2.1 General Description

Thank you for purchasing our DCC Dual Channel Controller. The DCC Dual Channel Controller is a comprehensive and dependable, self-contained system that offers one or two channel configurations for monitoring toxic and combustible gases and PID TVOCs with straight-forward control functionality for non-hazardous, non-explosion rated, commercial and light industrial applications. The monitoring of more electrochemical gas sensor choices or other gases such as CO<sub>2</sub> or refrigerants (solid state or infrared) can be accommodated by connecting the DCC to a remote 4-20 mA transmitter.

The DCC is available in the following one or two channel configurations:

- One internal electrochemical sensor
- One remote ESH-A catalytic sensor or remote 4-20 mA transmitter
- Two internal electrochemical sensors (one must be CO)
- One internal electrochemical sensor + one ESH-A remote combustible gas sensor or remote 4-20 mA transmitter

The DCC features two 4 - 20 mA outputs with VFD control and one configurable 4 - 20 mA input, two alarm level line voltage, SPDT dry contact relays with field configurable time delays and trigger levels, a field selectable internal audible alarm and an LCD/LED panel indicating channel alarm status and fault conditions. Optional factory installed features include, an extra loud door mounted buzzer for noisy environments or a water tight buzzer for wet applications, an internal enclosure heater for cold environment applications, a top mounted strobe and a splash guard for protection in wet applications.

Automated calibration and other maintenance procedures are simple and easily performed in the field, and our proprietary Calibration Extending Firmware (CEF) takes into account the aging of the toxic sensors so that less frequent calibrations are required in less-critical applications such as parking garages/car parks.

If after reading through the manual, you have any questions, please do not hesitate to contact our service department for technical support.

### 2.2 Key Features

- Single or dual channel operation
- Flexible internal and/or remote sensor configurations
- Two line LCD display with embedded LED indicators for CH1, CH2 and Fault
- Two 5-amps SPDT dry contact relays
- Two 4-20 mA outputs including VFD Control
- One configurable 4 - 20 mA input
- Thermal resetting fuses
- RoHS compliant circuit boards



- Standard water / dust tight, corrosion resistant enclosure (drip proof); IP54 rated with optional splash guard installed.

## 3 INSTRUMENT SPECIFICATIONS

### 3.1 Technical Specifications

#### GAS TYPE

Electrochemical (internal)	Carbon Monoxide (CO), Nitrogen Dioxide (NO <sub>2</sub> ), Nitric Oxide (NO), Oxygen (O <sub>2</sub> ), Hydrogen Sulphide (H <sub>2</sub> S), Ethylene (C <sub>2</sub> H <sub>4</sub> ), Sulphur Dioxide (SO <sub>2</sub> )
Combustible (catalytic) (remote ESH-A Sensor)	Hydrogen (H <sub>2</sub> ), Methane (CH <sub>4</sub> ), Propane (C <sub>3</sub> H <sub>8</sub> )
TVOCs (solid state) (remote ESH-A Sensor)	See Section 4.2 <i>List of Available Remote Sensors</i> for more information.
More Gas Types Remote 4-20 mA Analog Transmitters	AST-I Industrial Infrared CO <sub>2</sub> Transmitter AST-IS Industrial or Standard CO <sub>2</sub> Transmitter ART Infrared Refrigerant Transmitter CXT Explosion Proof Transmitter LPT Lower Power Transmitter LPT-A Analog Transmitter

For information on the remote transmitter sensor options, please refer to that product's Operation Manual.

#### MECHANICAL

Enclosure	ABS / Polycarbonate, rated UL94-5VA; IP54 rated with optional splash guard installed. Copper coated interior to reduce RF interference.
Weight	600 g (1.4 lb)
Size	254 mm x 218 mm x 109 mm (10.0" x 8.6" x 4.3")

#### ELECTRICAL

Power Requirement	
Low Voltage	16 - 30 VDC or 12 - 30 VAC, 10W, Class 2
Line Voltage	90 - 240 VAC, 50 - 60 Hz
Installer Supplied Power	
Low Voltage	400 mA @ 24 VDC (400 mA RMS @ 24 VAC)
Line Voltage (110 VAC)	Approximately 90 mA
Line Voltage (220 VAC)	Approximately 45 mA
	@24 VDC DCC draws 2.5 W
	@24 VAC DCC draws 3.5 VA
	@120 VAC DCC draws 3.5 VA

Wiring	<p>Low Voltage: - 24VDC or 24VAC two-conductor shielded 18 awg stranded within conduit</p> <p>Line Voltage: - VAC three-conductor (Line, Neutral, Ground) shielded 18 awg stranded within conduit</p>
Relays	Two SPDT dry contact relays, rated 5 amps @ 240 VAC
Distance	Maximum 200 ft (61 m) between controller and ESH-A Remote Sensor using minimum 18 gauge wire stranded within conduit.
Fuse	Automatic resetting thermal

## USER INTERFACE

Display	2-lines, 16-character LCD display with LED Panel indicating "CH1" state, "CH2" state, and FAULT"
---------	--

## INPUT / OUTPUT

Input	One 4-20 mA analog input
Output	<p>- Two 4-20 mA analog outputs</p> <p>- 24 volt 300 mA (depends on device) connector for remote strobe/horn (J8)</p>
"SILENCE" Push Button	Temporarily clears buzzer and latched relays
Audible Alarm	<p>- Internal audible alarm, rated 76 dB @ 3 m (10 ft)</p> <p>- Optional extra loud, door mounted buzzer, rated 90 dB @ 3 m (10 ft)</p>

## ENVIRONMENTAL *(sensor dependent)*

Operating Temperature <i>(depends on sensor)</i>	-20°C to 40°C (-4°F to 104°F), -40°C / -40°F with internal heater installed
Operating Humidity	15 - 90% RH non-condensing

## CERTIFICATIONS

Model: DCC-X-XXX  
 S/N: DCCA151200010  
 Rating: 90-240 VAC, 50-60 Hz  
 16-30 VDC or 12-28 VAC, 10W, Class 2



CERTIFIED FOR ELECTRIC SHOCK & ELECTRICAL FIRE HAZARD ONLY. LA CERTIFICATION ACNOR COUVRE UNIQUEMENT LES RISQUES DE CHOC ELECTRIQUE ET D'INCENDIE D'ORIGINE ELECTRIQUE.

Conforms to: CSA-C22.2 No. 205-M1983 (R2009), UL508 (Edition 17):2007

Conforms to: EMC Directive 2004/108/EC, EN 50270:2006, Type 1, EN61010

Conforms to: FCC. This device complies with Part 15 of the FCC Rules. Operation is subject to the following two conditions: (1) This device may not cause harmful interference, and (2) this device must accept any interference received, including interference that may cause undesired operation.

## NOTES:

- System is configured such that all relays are "FAIL SAFE" (relay coils are always energized in non-alarm state).
- Relays are "common" to both channels (activated by either channel).

## 3.2 Enclosure Dimensions

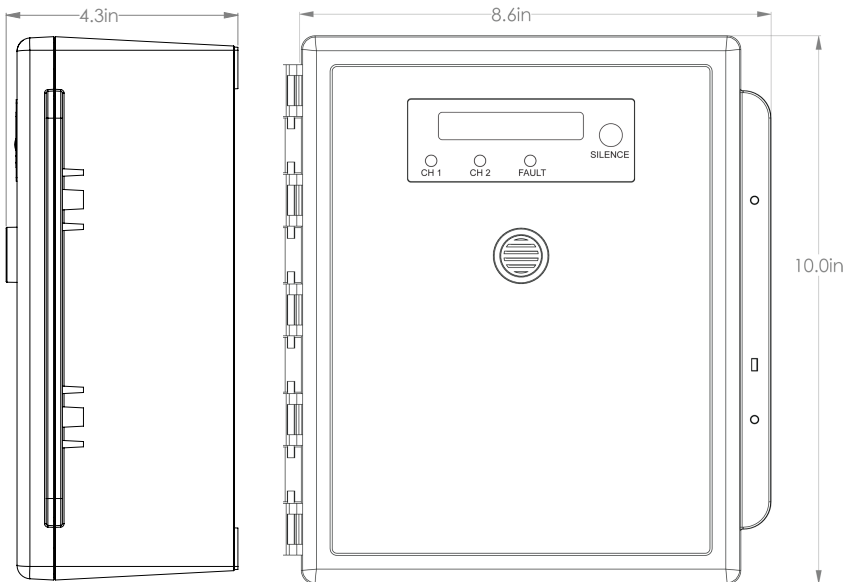

## 4 SENSOR SPECIFICATIONS

### 4.1 List of Available Internal Sensors

Internal Electrochemical Sensors	Part Number	Range	Lifespan
Carbon Monoxide (CO)	DCC-A-COB	0 - 200 ppm	6 years
Ethylene (C <sub>2</sub> H <sub>4</sub> )	DCC-A-C2H4	0 - 200 ppm	3 years
Hydrogen Sulphide (H <sub>2</sub> S)	DCC-A-H2S	0 - 50 ppm	3 years
Nitric Oxide (NO)	DCC-A-NO	0 - 100 ppm	3 years
Nitrogen Dioxide (NO <sub>2</sub> )	DCC-A-NO2B	0 - 10 ppm	6 years
Oxygen (O <sub>2</sub> )	DCC-A-O2	0 - 25% Vol	3 years
Sulphur Dioxide (SO <sub>2</sub> )	DCC-A-SO2B	0 - 20 ppm	3 years

**NOTE:** Some of the sensors listed in this section have cross sensitivities to other gases (interfering gases). If you require more information, please consult with your Regional Sales Manager before ordering a specific sensor.

### 4.2 List of Available ESH-A Remote Sensors

#### ESH-A Remote Sensors - Combustible (Catalytic)

Hydrogen (H <sub>2</sub> )	ESH-A-CH2-100	0 - 100% LEL	5 years
Methane (CH <sub>4</sub> )	ESH-A-CH4-100	0 - 100% LEL	5 years
Propane (C <sub>3</sub> H <sub>8</sub> )	ESH-A-C3H8-100	0 - 100% LEL	5 years

#### ESH-A Remote Sensors - TVOC PID

TVOC PID	ESH-A-SPL	0 - 30 ppm	usage / application dependent
TVOC PID	ESH-A-SPH	0 - 300 ppm	

### 4.3 List of Available Remote 4-20 mA Transmitters (Gas Detectors)

#### All models of:

---

ART Infrared Refrigerant Transmitter

---

AST-I Industrial Infrared CO<sub>2</sub> Transmitter

---

AST-IS Industrial or Standard CO<sub>2</sub> Transmitter

---

CXT Explosion Proof Transmitter

---

LPT Low Power Transmitter

---

LPT-A Analog Transmitter

---

### 4.4 Special Considerations for Sensors

If you install the DCC when it arrives, the sensor(s) will not require a long warm up period (about 2 to 5 minutes). The sensors go through a burn in period at the factory, so they are ready for operation upon arrival. If the DCC is not installed within two weeks of delivery, the sensor(s) may require a longer warm up time to stabilize (approximately 48 hours) and provide accurate readings.

After installing a DCC with an Oxygen sensor, leave it to warm up for 2 hours before looking at the readings.

For an R11 refrigerant sensor, allow 30 minutes after calibration before considering the readings to be valid. The sensor's response to R11 refrigerant and to humidity levels can affect the readings of the DCC and can take up to 30 minutes after calibration to recover and stabilize.

Silicone, lead and chlorinated hydrocarbon vapours can poison catalytic sensors.

A bump test will help you determine if a sensor requires calibration. If the sensor still does not respond as it should after a successful calibration, it probably requires replacing.

Temperature affects calibration. It is important to ensure the calibration gas is at the appropriate temperature during calibration. If the sensor is being used in an extreme temperature range, calibration should be done in that same temperature range.

### 4.5 Calibration Extending Firmware (CEF) and Sensor Aging

DCC systems with integral electrochemical sensors have been programmed with our CEF. This firmware takes into consideration the aging of the electrochemical CO and NO<sub>2</sub> sensors so that less frequent calibrations are required in less-critical applications such as parking garages. The system tracks the age of the sensor and automatically compensates for the reduced output of the sensor as it ages.

## 5 FEATURES

### 5.1 Front Exterior Enclosure



NUMBER	FEATURE	FUNCTION
1	LCD Display	2-lines by 16-characters
2	SILENCE Button	Push button to clear buzzer and latched relays
3	LED Indicators	Indicates CH1, CH2 alarm status and unit Fault condition
4	Sensor Opening	To monitor diffused air and gas
5	Door Screws	Secures door
6	Secure Tag Opening	For securing door with zip tie or dated tag
7	Magnetic Calibration Trigger point	To enter calibration for Channel 1
8		To enter calibration for Channel 2

## 5.2 Interior System Layout

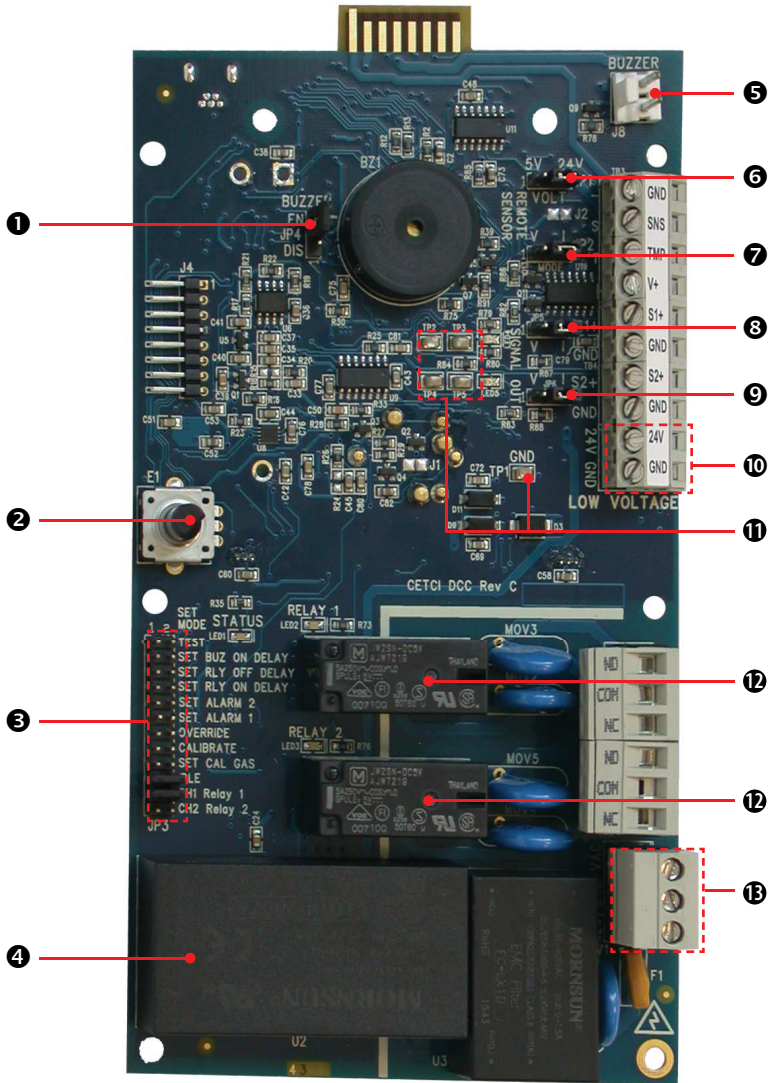

NUMBER	FEATURE	FUNCTION
1	Jumper JP4	Buzzer enable / disable
2	Rotary Encoder E1	Used for setting values in conjunction with jumpers

③	Jumper bank JP3 Config / Cal / Test Jumpers	Used to select different configuration and calibration modes
④	Power Supply Transformer	Provides low VDC power from 120 or 240 VAC input.
⑤	J8	Remote horn and/or strobe connector, provides 24V 300 mA (depending on the draw of the remote sensor that is connected)
⑥	Jumper JP1 Remote Sensor Voltage	Use to select the voltage required to power remote sensors; 5 V, 24 V.
⑦	Jumper JP2	Select voltage or current loop for input from the remote sensor
⑧	Jumper JP5	CH1 analog output voltage or current selection
⑨	Jumper JP6	CH2 analog output voltage or current selection
⑩	Low Voltage Wiring Terminal	For low voltage power connections and remote sensor hookup
⑪	Test Points	TP1 for multi-meter ground connection TP2 and TP3 monitoring Output 1 (S1) TP4 and TP5 monitoring Output 2 (S2)
⑫	Dry Contact Relays	For high & low alarm
⑬	High Voltage Wiring Terminal	For high voltage power connections and relay hookups

## 6 INSTALLATION

### 6.1 General Safety Warnings

The DCC is intended for indoor use, permanently mounted at breathing zone height (4 to 6 ft above ground, applicable to internal sensors) in parking garages and light industrial applications. It should be protected from extreme weather conditions. **For wet environment applications, use liquid tight conduit hubs wherever conduit enters the enclosure.**

The DCC requires no assembly and virtually no maintenance other than regular calibration of the integral and/or remote sensors and ensuring that excess water or dust is not somehow entering the enclosure and physically damaging the circuit board or internal components. There are no serviceable elements other than the calibration instructions outlined in this manual. There are no replaceable components except the sensors.

### 6.2 Protection Against Electrical Risks

Warning High Voltage. Indicates hazardous voltage may be present in the area inside the DCC enclosure marked with this symbol.





Disconnect all power before servicing. There may be multiple power sources.

Power supply must have a building installed circuit breaker /switch that is suitably located and easy to access when servicing is required and should be labelled as DCC supply (disconnecting power to the DCC). Appropriate markings should be visible at the circuit breaker / switch that is supplying power to the DCC.

This device may interfere with pacemakers. Modern pacemakers have built-in features to protect them from most types of interference produced by other electrical devices you might encounter in your daily routine. If you have a pacemaker, follow your healthcare provider's instructions about being around this type of equipment.

### 6.3 Protection Against Mechanical Risks

Be aware that the DCC enclosure has a hinged door that could potentially pinch fingers and the sharp edges and/or jumper pins on the board could potentially prick or cut fingers if not handled carefully.

### 6.4 System Installation

The DCC should be installed on a flat vertical surface using the four 0.175" (4.4 mm) diameter mounting holes provided to maintain water tight status. There are also four areas that can be drilled out for mounting to a double gang electrical box.

There are six conduit entry points for the standard mounting setup (against a flat surface). Three entry points are located along the top of the enclosure and three are located along the bottom. These points must be drilled out as needed. If mounting to a double gang electrical box there is an entry point provided that must also be drilled out of the back of the enclosure. Refer to Section 6.6 *Standard Enclosure Mounting Components*.

**NOTE:** When mounting the enclosure, allow enough room to allow the end user to open the door fully to access the internal adjustments.

Care should be taken to ensure that the face of the DCC is not obstructed in order to maximize the sensor's exposure to the environment being monitored.

When finished installing or servicing it is recommend you perform a bump test to ensure the unit and all relays are working properly.

#### 6.4.1 Wet Environment Considerations

If the DCC is to be installed in a potential hose-down application or any application whereby liquid could be directed towards the sensor opening, the DCC should be ordered with an optional attached splash guard (factory installed).

**If used in a wet or wash down application, the conduit hub entering the DCC enclosure must be liquid tight type.**

Any water or physical damage to the transmitter that occurs from the installer drilling their own installation holes will not be covered under warranty.

## 6.4.2 EMI and RF Interference Considerations

All electronic devices are susceptible to EMI (Electromagnetic Interference) and RFI (Radio Frequency Interference). Our controllers and detectors have been designed to reduce the effects of these interferences and we meet CSA FCC and CE requirements for these type of devices. However there are still circumstances and levels of interference that may cause our equipment to respond to these interferences and cause them to react as if there has been gas detected.

There are some installation procedures that will reduce the likelihood of getting faulty readings:

1. Locate the detectors and controllers out of the way from normal foot traffic and high energy equipment.
2. Confirm the devices are properly grounded using conduit and shielded cabling.
3. Inform operators and technical staff working in the surrounding area to be aware of these possible conditions and that two way radios, Bluetooth enabled devices, cell phones and other electrical equipment may interfere with the response of the gas detectors.

## 6.5 Sensor Mounting Heights

The sensor mounting height depends on the density of the gas relative to air. Heavier than air gases should be detected 6 inches from the floor, lighter than air gas sensors should be placed on or near the ceiling, and gases which have a density close to that of air should have sensors installed in the "breathing zone" 4 - 6 feet from the floor. The breathing zone refers to the area 4 - 6 feet from the floor, where most human breathing takes place. This is a good default location for sensors, as many gases are often well dispersed in air.

GAS	APPLICATIONS / TYPES	SUGGESTED MOUNTING HEIGHT
Carbon Monoxide (CO)	Fire Halls	4 - 6 ft above the floor
Nitrogen Dioxide (NO <sub>2</sub> )	Diesel Powered Equipment	4 - 6 ft above the floor
Nitric Oxide (NO)	Welding	4 - 6 ft above the floor
Oxygen (O <sub>2</sub> )	Hospitals	4 - 6 ft above the floor
Hydrogen Sulphide (H <sub>2</sub> S)	Oil and Gas Industry	4 - 6 ft above the floor
Ethylene (C <sub>2</sub> H <sub>4</sub> )	Fruit Ripening Rooms	4 - 6 ft above the floor
Sulphur Dioxide (SO <sub>2</sub> )	Pulp and Paper Mills	4 - 6 ft above the floor
Refrigerants	Chiller rooms	6" above the floor
Propane (C <sub>3</sub> H <sub>8</sub> )	Ice Arenas	6" above the floor
Hydrogen (H <sub>2</sub> )	Battery Charging Rooms	On or near the ceiling
Methane (CH <sub>4</sub> )	Waste Water Treatment Plants	On or near the ceiling

**NOTE:** CETCI considers 4 - 6 ft from the floor as the "Breathing Zone".

## 6.6 Standard Enclosure Mounting Components

### 6.6.1 Enclosure Interior Base

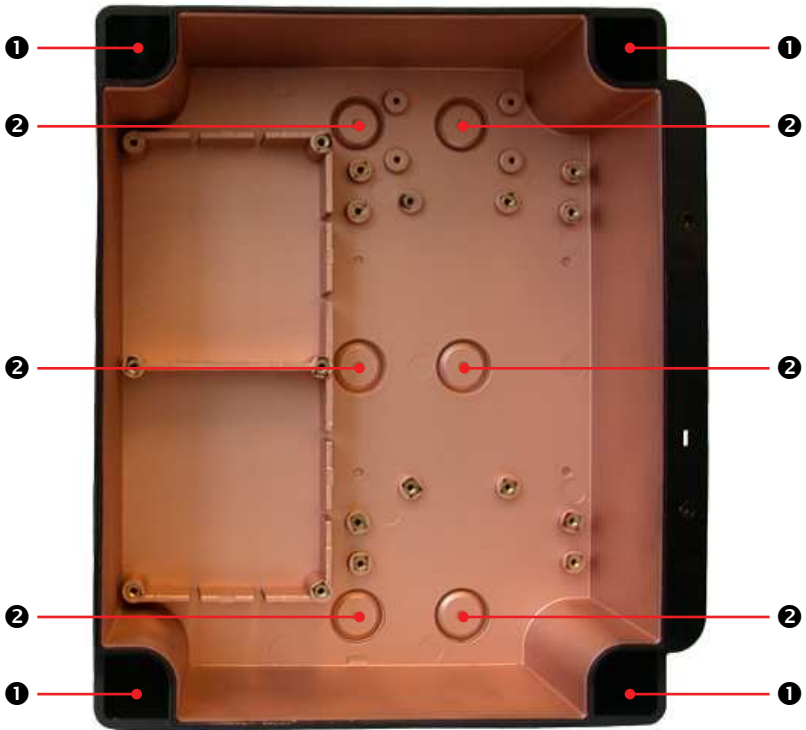

NUMBER	FUNCTION
1	Molded-in mounting holes
2	Conduit entry (6 entries on base)

### 6.6.2 Enclosure Top

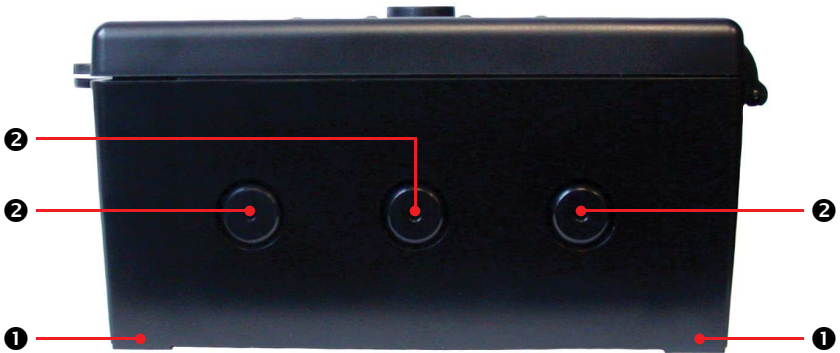

NUMBER	FUNCTION
1	Molded-in mounting holes
2	Conduit entry (3 entries on top)

### 6.6.3 Enclosure Bottom



NUMBER	FUNCTION
1	Molded-in mounting bracket
2	Conduit entry (3 entries on bottom)

## 6.7 Wiring Power Connections

Drill out one or more of the PVC conduit entry hole plugs located on the top, bottom or back of the DCC enclosure base. Refer to Section 6.6 *Standard Enclosure Mounting Components*.

All wiring should be run within properly grounded (earth or safety) conduit. Signal output and supply should be in shielded cable. The cable shield should be connected to earth ground at the controller/power supply that is providing power for the DCC. Low voltage wiring must not be within the same conduit as line voltage wiring.

**NOTE: WARRANTY MAY BE VOID IF DAMAGE OCCURS TO CIRCUIT BOARD COMPONENTS FROM THE USE OF SOLID CORE WIRE ATTACHED DIRECTLY TO THE WIRING TERMINALS.** When using solid core wiring for distribution (in the conduit), use stranded wire pigtails 18 awg within the enclosure to connect to the circuit board. The rigidity of solid-core wire can pull a soldered terminal strip completely off a circuit board and this will not be covered under warranty.

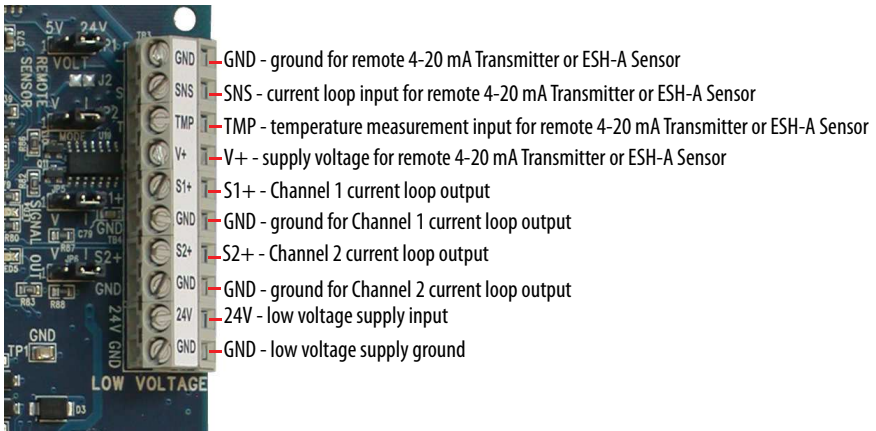

### 6.7.1 AC and DC Low Voltage Power Wiring to the DCC

If supplying 24 VAC connect both lines to the 24V and the last GND at the bottom of TB3. (See image above)

If supplying 24 VDC, make sure you connect the 24V to the 24V and the last GND to GND at the bottom of TB3. (See image above)

A class 2 or better transformer must be used. The stated max current draw of the DCC in this mode is 400 mA.

### 6.7.2 AC Line Voltage Power Wiring to the DCC

If supplying line voltage (90 - 240 VAC), connect L1 to L on TB1 located at the bottom right of the board. Connect L2 to N and earth ground to the chassis ground terminal on the same block.

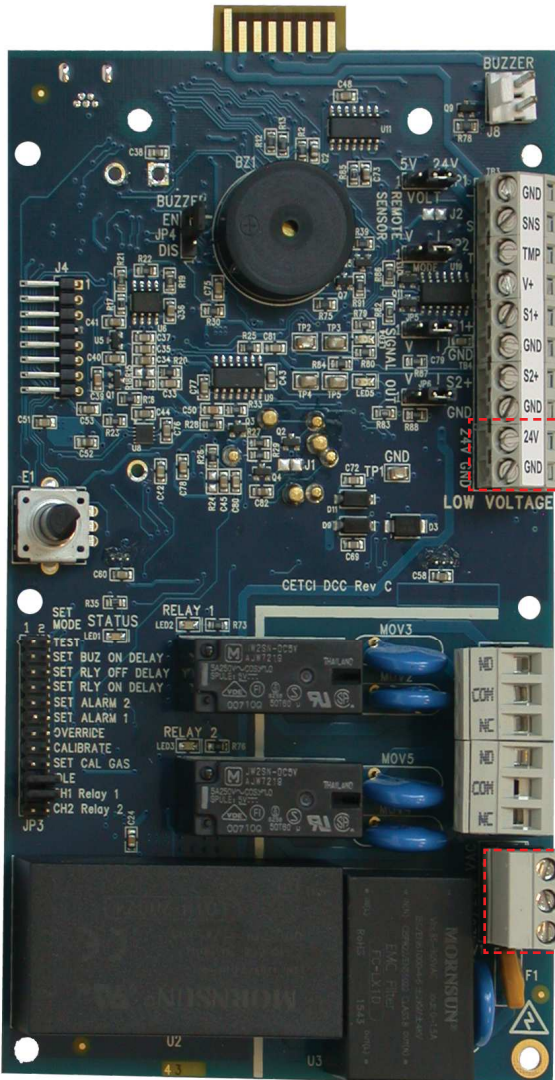

If supplying 24 VAC / VDC operational power, pull two wires suitable for low voltage from power source to both terminals labeled 24 V on block TB3.

If supplying line voltage, wire to terminals L, N and earth ground on block TB1.

## 6.8 Wiring Connections to a Remote Device

The DCC provides screw down wiring terminals for connecting:

- A remote 4 - 20 mA transmitter such as an LPT or LPT-A
- An ESH-A Remote Sensor

Confirm voltage requirements of device and set JP1 correctly.

Terminal blocks are also provided to connect to the two 5A / 250 VAC - 30 VDC relays. The relays do not supply power. (See Section 6.10 *Relay Connections* for more information.)

**NOTE: WARRANTY MAY BE VOID IF DAMAGE OCCURS TO CIRCUIT BOARD COMPONENTS FROM THE USE OF SOLID CORE WIRE ATTACHED DIRECTLY TO THE WIRING TERMINALS.** When using solid core wiring for distribution (in the conduit), use stranded wire pigtails 18 awg within the enclosure to connect to the circuit board. The rigidity of solid-core wire can pull a soldered terminal strip completely off a circuit board and this will not be covered under warranty.

### 6.8.1 Wiring from DCC to a Remote Transmitter or ESH-A Remote Sensor

**Each ESH-A is given the same serial number as the device it is being connected to. Make sure to connect the ESH-A to the DCC that has the same serial number or the system won't work.**

To connect a remote 4 - 20 mA current loop transmitter or ESH-A Remote Sensor use terminal block TB3.

- For a two-wire connection, wire to positions V+ and SNS.
- For a three-wire setup connect the third wire to the GND position of TB3.

Three-conductor, 16 - 18 gauge wire / cable must be shielded when connecting to a remote analog transmitter. The LPT series of remote analog transmitter enclosures have several conduit entry locations (general purpose enclosure).

**NOTE:** The ESH-A Remote Sensor has a temperature sensor which should be wired to the TMP position of TB3.

Under most local electrical codes, low voltage wires cannot be run within the same conduit as line voltage wires.

## Correct Wiring Example: DCC to Remote 4 - 20 mA Transmitter or ESH-A Remote Sensor

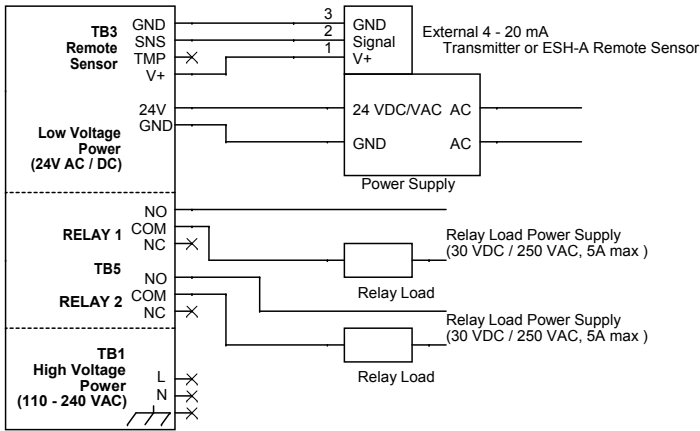

**NOTE:** Check the positions of jumpers JP1 and JP2 before powering up a setup with a remote transmitter. Incorrect positions of the jumpers will result in the remote transmitter not turning on and the DCC will require a restart. Reference Section 7.4 *Jumpers* to determine the appropriate positions.

### 6.8.2 Wiring from DCC to a Remote Strobe/Horn

The connection for a remote strobe/horn is J8, at the top right corner of the board. Refer to Section 5.2 *Interior System Layout* for location of J8. Use J8 to connect any 24 VDC strobe, horn or strobe/horn combo, including CETCI's Strobe/Horn combo (p/n: **RSH-24VDC**), Top Mounted Strobe (Option -L) or door mounted water tight buzzer (Option -WA). When in alarm, pushing the SILENCE button will silence/turn off the remote device.

## 6.9 Incorrect Wiring Examples (IMPORTANT)

It is important to make sure you connect the power and CETCI's remote devices to the DCC correctly to avoid damaging the DCC and/or the remote devices and putting yourself at risk of electrocution.

- If powering the DCC with 24 VDC you must respect the polarity and connect 24 V to 24 V and GND to GND.
- If supplying 24 VAC/VDC to any other port on TB3 other than the 24 V connection you risk damaging the DCC.
- Building wiring (L or N) connected anywhere on TB3 will destroy the DCC. It also creates the risk of electrocution because high voltage will exist outside the marked high voltage area.
- Building wiring (L or N) connected to the earth ground on TB1 will destroy the circuit board and cause a short in the system.
- In most instances, if you incorrectly connect a remote transmitter, such as an LPT-A, to the DCC, the LPT-A will not power up and the DCC will eventually go into fault. For example, if the LPT-A GND



wire is connected to the DCC V+ on TB3 and LPT-A V+ wire is connected to DCC GND, the LPT-A will not power up and DCC will eventually go into fault.

- If the LPT-A signal line connected to DCC TMP on TB3 will result in the LPT-A powering up but the DCC will not receive a signal and will eventually go into fault.

**NOTE:** If connecting third party remote devices, consult that manufacturer's wiring instructions. CETCI is not responsible for incorrectly wiring third party devices and warranty may not cover resulting damage from incorrectly wired third party devices.

## 6.10 Relay Connections

The DCC has two dry contact relays that are designed to operate fan starters or coils to control equipment that draws no more than 5 amps @ 240 V start-up and / or operational current.

The system does not provide any power from these terminals. Dry contacts operate like a switch to simply activate (switch on) or de-activate (switch off) equipment to be controlled, such as fan starters.

The system relays are SPDT (single pole, double throw) thereby providing one set of usable dry contacts for each relay. Because the DCC series systems are designed to be fail-safe, any equipment to be controlled by the system relays should be wired to the "NC" (Normally closed) and "COM" (Common) terminals. **The relay coils are normally energized in non-alarm state for failsafe operation.**

## 7 OPERATION

### 7.1 General System Operation

The DCC continuously monitors target gas concentrations on one or two configured channels.

Upon application of power the LCD display will turn on and the Channel LED for each configured channel will blink Green during warm up. All alarms will be disabled for two to five minutes (depending on the gas) during the system warm up period. After the warm up period, the system may exhibit gas alarm condition(s) if one or both of the sensors has not completely stabilized during the warm up period. This is normal and the length of time the gas alarms exist is dependent upon the length of time since the unit was last powered up, and the state of the environment it is installed in.

After warm up, the LCD will show the gas type, gas reading and gas units. The LED for each installed channel will be illuminated GREEN indicating normal operation and that the relays are energized indicating normal "Fail-safe" NO ALARM status.

### 7.2 Display Select

There are two display mode options to choose from: normal display mode and minimal display mode. The factory default setting is the normal display mode, which will display the gas type, gas reading and gas units for CH1 and CH2.



The minimal display mode can be set from the test menu. This mode will only display the gas type for CH1 and CH2. To change the display mode, see Section 7.5 *Test/Config Mode Functions*.

### 7.3 Fault Detection

The DCC has built in fault detection. In the event of a problem with the measurement circuitry or a sensor sending a reading below zero, the unit will indicate a fault condition on the display. The FAULT LED will turn solid RED and the CH1 or CH2 LED that has the fault will blink RED and a question mark will appear next to the reading.

Normal operation will resume once the fault condition has been corrected.

**NOTE:** To ensure safe operation, periodic bump tests are required. A damaged solid state or catalytic sensor will go open circuit and create a fail indication on the DCC.

**NOTE:** How the relay, buzzer and analog outputs for CH1 and CH2 respond during a fault condition are field configurable.

**NOTE:** If a question mark ? is displayed (and the FAULT LED is not lit) then the system is in a minor fault and a re-zeroing is recommended.

### 7.4 Jumpers

There are five single jumper positions (JP1, JP2, JP4, JP5 and JP6) and one bank of 12 jumpers (JP3). JP3 provides the ability to monitor and configure a wide range of values. To start a configuration, place one jumper on the channel / relay select position CH1 Relay1 or CH2 Relay 2 and place the other jumper on the function position you want to configure:

POSITION NAME	FUNCTION
TEST	Puts the unit into test/config mode
SET BUZ ON DELAY	Configure internal audible alarm ON delay
SET RLY OFF DELAY	Configure selected Relay OFF delay
SET RLY ON DELAY	Configure selected Relay ON delay
SET ALARM 2	Enable/Disable/Set selected Channel alarm 2 level
SET ALARM 1	Enable/Disable/Set selected Channel alarm 1 level

OVERRIDE	Used during calibration to override a zero or span value that is out of nominal range
CALIBRATE	Begin the calibration procedure
SET CAL GAS	Adjust the gas concentration used in calibration
IDLE	Jumper default position (no connection)
CH1 Relay 1	Select CH1 or Relay 1
CH2 Relay2	Select CH2 or Relay 2

To end a configuration and save the changes, move the jumper from the function position back to the IDLE position. The other jumper can remain on the channel / relay select position.

**IMPORTANT:** During normal operation, one jumper should rest in one of the channel / relay select positions (CH1 Relay1 or CH2 Relay 2) and the other should rest in the IDLE position.

*Refer to Section 5.2 Interior System Layout for jumper locations.*

## 7.5 Test/Config Mode Functions

The test/config mode allows you to test and configure the basic functionality of the system.

To enter test/config mode move the JP3 Jumper from IDLE to the TEST position. When the device enters the test/config mode the buzzer will beep several times and the LEDs will cycle to test their function. Watch for both green and red on the channel LEDs (especially if damage is suspected).

To test the magnetic sensors, in test mode touch the magnetic wand to the white dot (above the D of DCC on the front of the DCC enclosure). The CH1 LED should light up. Use the magnet to touch the second magnetic sensor (white dot above the second C). The CH2 LED should light up.

The Test/Config mode will exit automatically after 5 minutes of no activity. To exit the Test/config mode, move the jumper back to IDLE. Upon exit the unit will return to standard measurement mode.

**NOTE:** Analog outputs will stay at the level they were currently at prior to entering test/config mode.

### 7.5.1 How to Navigate the Test/Config Menu

Use the rotary encoder to scroll through the menu selections. Press the SILENCE button to choose the desired menu item. A ">" will appear to the left of the item menu value. Use the encoder to cycle through the possible options (ON/OFF, YES/NO, etc.). Press the SILENCE button to save the selection and return to the main menu. To cancel, remove the jumper from the test position back to IDLE.

### 7.5.2 Hold Relay #

The Hold Relay functionality allows you to trip or untrip Relay 1 and/or Relay 2 for testing purposes. Enter test/config mode. Use the rotary encoder to scroll to **Hold Rly#** and press the SILENCE button to enter the menu item. Turn encoder clockwise to trip the relay. To untrip the relay, turn the encoder counterclockwise.

Press the SILENCE button to exit the menu item and clear the relays. The state in which you have set the relay will remain until you remove the TEST jumper and put it back to IDLE.

### 7.5.3 Disable Channel #

Enable or disable one or both gas channels. Enter test/config mode. Use the rotary encoder to scroll to **CH# ON/OFF** and press the SILENCE button to enter the menu item. Use the encoder to choose ON or OFF and press the SILENCE button to save and return to the main menu.

**NOTE:** You can only enable factory configured channels. If you try to enable a non-configured channel the display will read Bad Config in normal operation.

### 7.5.4 Display Mode

Set the preferred display mode - regular display or minimal display. Enter test/config mode. Using the rotary encoder, scroll to **Display Style** and press the SILENCE button to enter the menu item. Use the encoder to choose the preferred display mode. Press the SILENCE button to save and return to the main menu.

### 7.5.5 CH# Current Test

To test the 4-20 mA analog output operations for each channel. Enter test/config mode. Use the rotary encoder to scroll to **CH# Current Test** and press the SILENCE button to enter the menu item. Use the encoder to dial the output up or down. Each turn progresses in increments of 1 mA. Press the SILENCE button to return to the main menu.

### 7.5.6 CH# Current Calibration

To calibrate the analog output for each channel. Hook a multi-meter (ammeter) to the analog output port. Enter test/config mode. Use the rotary encoder to scroll to **CH# Current Cal** and press the SILENCE button to enter the menu item. Calibrate the zero by using the encoder to adjust the counts until the desired current is displayed on the multi-meter. Press the SILENCE button to move to the 4 mA setting and repeat the process. Repeat again for 20 mA. Press the SILENCE button to return to the main menu.

### 7.5.7 Output CH1 Max Follow

To enable the output of CH1 to follow the highest level of both gas channels. Enter test/config mode. Use the rotary encoder to scroll to **Out# Max Follow** and press the SILENCE button to enter the menu item. Use the encoder to choose the preferred setting and press the SILENCE button to save and return to main menu.

### 7.5.8 CH# Alarm# Direction

Use to set the direction (ascending or descending) of the selected alarm. Enter test/config mode. Use the rotary encoder to scroll to **CH# Alarm# Dir** and press the SILENCE button to enter the menu item. Use the encoder to choose the preferred setting and press the SILENCE button to save and return to main menu.

### 7.5.9 CH# Change 4-20 mA Output to 0-20 mA output

Use to choose the current output range for the Channel. Enter test/config mode. Use the rotary encoder to scroll to **Output# mA Range** and press the SILENCE button to enter the menu item. Use the encoder to choose the preferred setting and press the SILENCE button to save and return to main menu.

### 7.5.10 Output CH# Fault Level

Use to set the current level to be output during a FAULT condition. Enter test/config mode. Use the rotary encoder to scroll to **Out# Fault Lvl** and press the SILENCE button to enter the menu item. Use the encoder to choose the preferred setting and press the SILENCE button to save and return to main menu.

### 7.5.11 Relay Fault State

Use to set the state the relay takes during a FAULT condition. Enter test/config mode. Use the rotary encoder to scroll to **Rly# Fault State** and press the SILENCE button to enter the menu item. Use the encoder to choose the preferred setting and press the SILENCE button to save and return to main menu.

### 7.5.12 Buzzer Fault State

Use to set the state (ON or OFF) the buzzer takes during a FAULT condition. Enter test/config mode. Use the rotary encoder to scroll to Buzz Fault State and press the SILENCE button to enter the menu item. Use the encoder to choose the preferred setting and press the SILENCE button to save and return to main menu.

### 7.5.13 Relay Latching

Use to enable or disable relay latching. Enter test/config mode. Use the rotary encoder to scroll to **Rly# Latching** and press the SILENCE button to enter the menu item. Use the encoder to choose the preferred setting and press the SILENCE button to save and return to main menu.

### 7.5.14 Relay Hold Off Enable/Disable

Use to enable or disable the ability to hold-off, or clear a relay. Enter test/config mode. Use the rotary encoder to scroll to **Rly# Holdoff** and press the SILENCE button to enter the menu item. Use the encoder to choose the preferred setting and press the SILENCE button to save and return to main menu.

### 7.5.15 Setting the Hold Off Time Relay

If Relay Holdoff is enabled (see Section 7.5.14 *Relay Hold Off Enable/Disable*) and the unit has just gone into alarm, pressing the SILENCE button for 5 seconds will clear the buzzer and the relay will delay the alarm from sounding again until the Hold Off time has completed. The Hold Off duration is global to both relays. The Hold Off feature is disabled by default.

To set the Hold Off Time, enter test mode and use the rotary encoder to scroll to **Rly Holdoff Sec**. Press the SILENCE button to enter the menu item. Use the encoder to choose the preferred setting and press the SILENCE button to save and return to main menu.

## 7.6 Audible Alarm / Buzzer Operation

The DCC comes with an internal audible alarm/buzzer that can be enabled or disabled using the jumper on JP4. The buzzer is enabled by default. An optional, door mounted, extra loud 24V buzzer is also available. The external buzzer uses the same signal line and enable/disable jumper.

The audible alarm is linked to the second alarm point for each installed channel. The buzzer will sound once the gas for a specific channel passes the second set point. If the configurable buzzer ON DELAY has been set the delay will begin counting down the moment the set point is reached. If the gas level drops below the set point before the delay completes the buzzer will not sound. If you want the buzzer to go

off at the low alarm setpoint, set ALARM 2 lower than ALARM 1. Refer to Section 7.8 *Adjusting Alarm Set Points* for more information.

Pressing the SILENCE button will stop the buzzer or any external audible device the DCC is connected to for a set amount of time. The factory default set amount of time is 5 minutes. If a different set amount of time is required, this needs to be specified at the time of order.

## 7.7 Setting Buzzer ON Delay

To set the ON delay for the on board buzzer move the jumper from the IDLE position on JP3 to SET BUZ ON DELAY. The max delay for the buzzer is also 20 minutes and the rotary encoder increments it in 10 second steps. To save the changes, move the jumper back to the IDLE position.

**NOTE:** The buzzer delay is local to the buzzer and applies regardless of the channel causing the alarm.

## 7.8 Adjusting Alarm Set Points

The DCC is configurable as single or dual channel detector and has two gas alarm set points for each channel. Almost all installations of the DCC will use the factory default alarm set points.

Default set points are as follows:

SENSOR / GAS	MEASUREMENT RANGE	LOW ALARM (ALARM 1)	HIGH ALARM (ALARM 2)	
CO	0 - 200 ppm	25 ppm	100 ppm	default
NO <sub>2</sub>	0 - 10 ppm	0.7 ppm	1.5 ppm	default
O <sub>2</sub>	0 - 25 % vol	19.5 % vol	23.0% vol	default
H <sub>2</sub> S	0 - 05 ppm	10 ppm	15 ppm	default
SO <sub>2</sub>	0 - 20 ppm	2 ppm	5 ppm	default
Refrigerants	0 - 2,000 ppm	250 ppm	1,000 ppm	default
C <sub>3</sub> H <sub>8</sub>	0 - 100% LEL	10% LEL	20% LEL	default

**NOTE:** Alarm values for CH<sub>4</sub> and H<sub>2</sub> are the same as for C<sub>3</sub>H<sub>8</sub>.

To change an alarm point place one jumper on the CH1 Relay 1 or CH2 Relay 2 position (depending which channel you are configuring) and place the other jumper on either SET ALARM 1 or SET ALARM 2 depending on the alarm you wish to set. Turn the rotary encoder to increase or decrease the level. To save the changes, move the jumper on the SET ALARM position back to IDLE.

**NOTE:** ALARM 1 is "low alarm" and ALARM 2 is "high alarm" by default. The set points can be changed so that ALARM 1 is higher than ALARM 2. However, the LED and relay behaviour will not change, i.e. once alarm point 2 is reached, RELAY 2 will trip and the channel LED will show red, regardless of whether alarm point 1 has been reached. The buzzer is linked to ALARM 2. If you want the buzzer to go off at the low alarm point, set ALARM 2 as "low alarm" and set ALARM 1 as "high alarm".

**NOTE:** You can enable or disable the alarm by pressing the SILENCE button while setting the alarm set point.

## 7.9 Setting Relay ON / OFF Delays

The DCC comes with configurable ON and OFF delays for both relays. In the event of a gas build up in excess of the level set for ALARM 1, RELAY 1 will be triggered and the front LED for the appropriate channel will change from GREEN to AMBER. If an ON DELAY has been set, the LED will change colour and blink but the relay will remain unchanged until the time delay has expired, at which time the relay will “trip” and the LED will change from flashing amber to solid amber. If the gas level falls below the set ALARM level before the delay has finished, the alarm will be cancelled and the delay will be reset for the next alarm.

Similarly, if the gas level builds up to a level in excess of the level set for ALARM 2, RELAY 2 will be triggered, and the LED for the appropriate channel will change from AMBER to RED. In addition, ALARM 2 will also trigger the audible alarm, if enabled.

When the gas level drops below the appropriate alarm threshold the RELAYS and LEDS will return to the state of the next lowest alarm point. If an OFF DELAY has been set, the LED will remain in its current colour and the relay will stay tripped for the duration of the RELAY OFF DELAY.

To set a delay, place one jumper on the CH1 Relay 1 or CH2 Relay 2 position (depending which channel you are configuring) and place the other jumper on either SET RLY ON DELAY or SET RLY OFF DELAY depending on the delay you wish to set. Turn the rotary encoder to increase or decrease the level. To save the changes, move the jumper on the SET RLY DELAY position back to IDLE.

**NOTE:** Each delay is local to the relay and independent of the tripping channel.

Each relay can be configured with one ON DELAY (maximum 20 minutes) and one OFF DELAY (maximum 20 minutes). The factory default settings for both relays are:

SENSOR / GAS	DEFAULT ON DELAY	DEFAULT OFF DELAY
CO	2 min	5 min
NO <sub>2</sub>	2 min	5 min
O <sub>2</sub>	0 min	0 min
H <sub>2</sub> S	0 min	0 min
SO <sub>2</sub>	0 min	0 min
Refrigerants	0 min	0 min
C <sub>3</sub> H <sub>8</sub>	2 min	5 min

When the alarm is triggered, a short press of the SILENCE button will clear the buzzer. The relays can be manually cleared by pressing and holding the SILENCE button for 5 seconds if HoldOff is enabled for each relay. (See Section 7.5.14 *Relay Hold Off Enable/Disable*)

If the relay has latching enabled, the alarm will not un-trip until the “SILENCE” button is pressed.



## 7.10 Minimum Runtime

The minimum runtime prevents the relay from untripping for a specified amount of time. The relay will remain tripped regardless of the gas level reading or user input. This feature is useful for preventing damage to motorized equipment.

**NOTE:** The minimum runtime is factory set and not field configurable.

## 7.11 Analog Output Characteristics

The default signal output mode is 4-20 mA current loop. Zero concentration gas will output 4 mA and full scale (e.g. 200 ppm CO) will output 20 mA. The output can be changed to voltage (2 - 10 v) moving the JP5 (CH1) and/or JP6 (CH2) jumpers to (V) volt.

$$\text{outputLevel} = [\text{gasReading} * (\text{outputRange} / \text{gasRange})] + \text{outputZero}$$

# 8 CALIBRATION

## 8.1 Calibration Specifications

### 8.1.1 Gas

Calibration span gases should have at least  $\pm 5\%$  accuracy (or better) and have a current date stamp. Gas generators should have a current dated cell installed. Service personnel should flow zero emissions air or 20.9% volume O<sub>2</sub> (scrubbed of hydrocarbons) before attempting to null adjust toxic gas sensors. In some cases N<sub>2</sub> can be substituted for zero air. Contact CETCI for clarification.

Every DCC controller is calibrated in a chamber by true diffusion method prior to leaving our facility. This method more closely emulates actual “real world” conditions. Field calibration using gas cylinder, regulator and hose directing span gas into the sensor may result in slightly higher readings. It is important to note that the type of gas mixture, how old the gas is and what temperature it has been stored at will also affect repeatability during field calibration.

### 8.1.2 Regulators & Flow

Calibration gases that are lighter than or the same weight as air (ie. CO) should be flowed at 0.5 LPM. Gases heavier than air (NO<sub>2</sub>, etc.) should be flowed between 0.5 and 1.0 LPM. Fixed flow regulators provide more accuracy.

### 8.1.3 Adapters

The proper calibration adapter should be utilized to allow the gas to properly diffuse around the sensor.



They are available from CETCI:

- Standard calibration adapter plug for sensor vent: p/n **CET-7000-CAP**
- Calibration adapter clip “Cal Clip” for splash guard: p/n **CET-SGC**
- Explosion proof calibration adapter: p/n **CXP-CAL**

#### 8.1.4 Calibration Frequency

- Parking garage detectors: Once every 12 months
- OHS applications: Once every 6 months (OHS: Occupational Health & Safety)

#### 8.1.5 Gas Testing Frequency (Bump Testing)

For the purpose of safety in OHS applications, sensors should be gas tested (bump tested) once every month to confirm response and alarm activation.

**NOTE:** A calibration label should be applied after every calibration to confirm work performed and the date it was confirmed. If a controller is involved, the alarm set points should be indicated on a label on the front door of the enclosure so anyone working in the environment can be aware.

Required Equipment: Calibration Kit, Calibration gases

Optional: Magnetic Wand

Users can order the Calibration Kit, calibration accessories and / or gases (shipping restrictions may apply) from any CETCI authorized distributor or they can supply their own gas and equipment as long as the gas meets the minimum specifications.

#### 8.1.6 Non-Intrusive Calibration with Magnetic Wand

Calibration can be initiated without opening the unit by using the magnetic sensors included within the DCC. This is particularly useful if in a wet or dirty environment. A magnet of sufficient strength will be required to trip the sensors. Such a magnet is included in the Calibration Kit (see Section 9.5 *Calibration Kit*) and can also be ordered separately from CETCI under part number **CET-MW**.

To initiate non-intrusive calibration, touch the magnet to the mark on the enclosure door. Both marks are indicated by a white dot that is slightly above and to either side of the sensor opening. The left position initiates calibration of CH1, the right position initiates calibration of CH2. Once calibration has begun follow the steps listed in Section 8.2 *Calibration Procedure* while watching the prompts on the display. To cancel the calibration process simply repeat the magnet touch used to initiate the process.

**NOTE:** Overrides cannot be done non-intrusively. If an override is required the door will need to be opened so the OVERRIDE jumper can be accessed.

## 8.2 Set the Span / Calibration Gas Level

The calibration procedure within the DCC has been designed to streamline the process. To begin, you must set the concentration of the span/calibration gas you are going to use.

**Step 1**

Ensure the Channel Select jumper on JP3 is set to the desired channel and move the other jumper to SET CAL GAS.

**Step 2**

Watch the display while turning the rotary encoder until the number displayed matches the gas concentration you are using.

**Step 3**

Once the calibration gas level has been set, move the jumper from SET CAL GAS to the IDLE position.

**8.3 Calibrating the Internal Sensor**

**NOTE:** If an inappropriate concentration of span gas is applied during calibration, calibration may succeed but it does not mean the equipment has been calibrated properly. CETCI is not responsible for improperly calibrated transmitters. Follow the manual instructions carefully.

**NOTE:** CETCI recommends flowing Zero air before starting calibration to ensure an accurate Zero reading. Attach the regulator to the cylinder of Zero air, insert calibration adapter into the sensor opening in the front of the enclosure door (see Section 8.4.1 *Calibration Adapter* if the adapter will not fit). Open the regulator valve fully allowing Zero air to flow over sensor for one minute.

**NOTE:** Spanning can be cancelled by removing the jumper from the CALIBRATE position and move to IDLE position **before** the spanning is finished and the controller will return to normal operation.

To calibrate the DCC's internal sensor, the user must do the following:

**Step 1**

Set the calibration gas concentration (refer to Section 8.2). Ensure the Channel Select jumper on JP3 is set to the desired channel and move the other jumper to CALIBRATE.

To calibrate the Zero or the Span only, turn the Rotary Encoder E1 counter-clockwise or clockwise, respectively and follow the prompts. If no selection is made the unit will proceed into auto-calibration.

**Step 2**

When auto calibration has started, watch the display to follow the prompts. The unit will begin with Zero Gathering, a collection of readings that are averaged and compared to the Zero Override/Fault limits.

**Zero Success:** If the average reading is acceptable, the new Zero value is saved and the unit starts the Span Calibration procedure.

**NOTE:** If the Zero is not successful, see Section 8.4.2 *Zero Override* or Section 8.4.3 *Zero Fault* to correct the error. If a zero shift is all that is desired, see Section 8.4.4 *Zero Shift*.

**Step 3**

Continue with the span gas calibration, when prompted. Attach the regulator to a cylinder of span gas.

Insert the calibration adapter into the sensor opening in the front of the enclosure door. Open regulator valve fully and allow span gas to flow over sensor.

Once gas flow is detected, the DCC will begin Gas Settling, which allows the sensor to achieve a steady state reading. Once the settling time is completed, the unit will display Spanning, while it gathers the gas readings. At the Span Compare stage, the collected readings are averaged and used to calculate the sensor sensitivity and compare it to the original sensitivity of the sensor at the time of installation. Then the percentage of sensitivity remaining for the sensor is compared to the Span Override and Fault Limits.

**NOTE:** If calibration is canceled at this point, the previous span value will be used in conjunction with the new zero value. CETCI is not responsible for incorrect calibration due to zero effect.

**Span Success:** If the sensitivity remaining is acceptable, the new Span value is saved, any DEAD\_FAULT flags are cleared and the unit waits for the jumper to be moved from CALIBRATE and placed back on IDLE.

**NOTE:** If the Span is not successful, see Section 8.4.5 *Span Override* or Section 8.4.6 *Span Fault* to correct the error.

**NOTE:** If DEAD\_FAULT appears on the display, see Section 8.4.7 *DEAD\_FAULT*.

## 8.4 Trouble Shooting Calibration

This section is intended to aid in correcting issues that may arise during the calibration procedure. If you are unable to correct a problem or you have questions, please contact our service department at [service@cetci.com](mailto:service@cetci.com) or 604-940-8741 (Local) or 1877-940-8741 (Toll Free).

### 8.4.1 Calibration Adapter

Use a slight twisting motion as you gently push the calibration adapter into the sensor opening. If the calibration adapter is hard to insert, moisten the O-ring seal slightly then try re-inserting it. If the splash guard is installed, use calibration adapter p/n: CET-8000-GRS.

**NOTE:** Response time will be slower with the splash guard installed.

### 8.4.2 Zero Override

If the average reading is outside the Override range, but inside the Fault Limits, move the Channel select jumper on JP3 to the OVERRIDE position and continue.

### 8.4.3 Zero Fault

If the average reading is outside the Fault Limits, the Zero is not saved and calibration must be restarted once the ambient gas is cleared. This could be caused by a cold sensor, usually affects solid state or catalytic sensors more than electrochemical sensors.

### 8.4.4 Zero Shift

If all that is desired is to do a Zero Shift calibration, remove the jumper from the CALIBRATE position once the unit has confirmed a Zero Success. Alternately, you can use the Zero only calibration by turning the encoder during the manual selection period at the start of the Calibration procedure. A Zero Shift

calibration is only done when the DCC is being installed for the first time. The reason is to compensate for the new environment in which the DCC is being installed.

#### 8.4.5 Span Override

If the sensitivity remaining is below the Override Limit, but above the Fault Limit (low), move the Channel select jumper on JP3 to the OVERRIDE position and continue. This indicates that approximately 10% to 20% of the original sensitivity of the sensor is left and you will need to replace the sensor soon.

#### 8.4.6 Span Fault

If the sensitivity remaining is below the Fault Limit (low) the display will show Span Fault and sets the DEAD\_FAULT flag to indicate a possibly dead sensor. This fault cannot be cleared without a successful calibration or factory reset. You can try to recalibrate, to confirm the procedure was followed correctly and this may correct the fault. If this does not correct the fault, please contact our service department at [service@cetci.com](mailto:service@cetci.com).

#### 8.4.7 DEAD\_FAULT

If no gas is detected after one minute, the DCC will set a DEAD\_FAULT for the sensor. This type of fault can only be cleared with a successful calibration or a factory reset.

### 8.5 Calibrating an Oxygen Sensor

When calibrating an Oxygen sensor, the process is reversed. The DCC will automatically start the Span calibration first and then Zero calibration. Follow the calibration procedure as listed in Section 8.2 *Calibrating the Internal Sensor*, **with the exception of doing the Span first and then the Zero.**

If a bottle of 20.9% Oxygen is being used make sure it is flowing before moving the CALIBRATE jumper. If the service person is confident of air quality and is careful (do not exhale in the direction of the Oxygen sensor being serviced while Span adjusting), Oxygen in the breathing environment can be used as a fairly accurate source of span gas (20.9% volume) "in a pinch". It is not recommended to use this procedure for all span adjustments of Oxygen sensors.

A bottle of 99.9% Nitrogen ( $N_2$ ) is required for the Zeroing procedure of calibration. Follow the prompts on the display.

### 8.6 Calibrating a New Internal Sensor (Rollback)

During the 5 minute period after a successful span calibration, if the jumper is not moved from the CALIBRATE position back to the IDLE position, the unit can be told that a new sensor has been installed. This will set the original sensitivity and original zero to those just calibrated for that sensor. To indicate a new sensor installation turn the rotary encoder counter-clockwise 2 turns. The display will confirm that the new sensor values have been set.

**NOTE:** Only reset original sensor values when a new sensor is installed, this operation is NOT REVERSABLE. CETCI is not responsible for improper calibration or sensors that cannot be calibrated due to improper use of this function.

## 8.7 Calibrating a Second Internal Sensor

To calibrate a second internal sensor, if installed, simply follow the instructions in Section 8.2 *Calibrating the Internal Sensor* while ensuring the Channel Select jumper is placed on the desired channel.

## 8.8 Calibrating a Remote 4-20 mA Transmitter

Calibration of a remote 4-20 mA transmitter should be accomplished at the individual transmitter. Follow the calibration procedure instructions in the Operation Manual for that particular remote transmitter. Every device is shipped with its corresponding manual. An electronic copy of the manual can also be downloaded from:

[www.critical-environment.com/support/product-library/operation-manual.html](http://www.critical-environment.com/support/product-library/operation-manual.html)

**NOTE:** The 4-20 mA input signal for the DCC is factory set and should not require changing in the field.

## 8.9 Calibrating an ESH-A Remote Sensor

There are two different processes for calibrating an ESH-A Remote Sensor. One process is for a new or replacement sensor and the other is for a properly functioning sensor.

### 8.9.1 Zero and Span Calibration of a Responsive ESH-A Sensor (done at the DCC)

If the sensor does not need to be replaced and is responding correctly but the regular calibration process at the DCC failed, the Zero and Span calibrations will need to be done at the controller or transmitter that the ESH-A is connected to.

Make sure both the DCC and the ESH-A Remote Sensor are powered up and have warmed up for a 24 hour period prior to calibration. Place the Channel select jumper on the DCC on the channel assigned to the ESH-A and follow the previously stated instructions outlined in Section 8.2 *Calibration Procedure* **with the exception that the gas should be applied to the ESH-A sensor opening instead of the DCC sensor opening.**

### 8.9.2 Zero Calibration of a New or Replacement Sensor

If a new replacement sensor has been installed, the ESH-A will require a Zero calibration of its sensor. This process will normally be required if the sensor has been replaced or there is concern that the sensor is not responding correctly.

Make sure the ESH-A Remote Sensor is powered up and has been warmed up for a 48 hour period prior to calibration.

1. Open the ESH-A Remote Sensor enclosure.
2. Move the jumpers from their resting position to JP1-1 and JP1-2 (bottom two jumper positions).
3. Apply the correct Null gas for the type of sensor installed, for a minimum of 2 minutes.
4. Attach a volt meter to TP1 and TP2.
5. Using the POT RN1 potentiometer (located on the left underside of the ESH-A board), adjust the voltage to read 0.40 VDC.

6. Return the jumpers to their original positions and close the ESH-A.
7. Verify the display of the DCC is reading Zero (a Zero and Span Calibration of the DCC will be required if this is not the case).
8. In the DCC, place the Channel Select jumper on the channel assigned to the ESH-A and follow the previously stated instructions for regular calibration outlined in Section 8.2 *Calibration Procedure* **with the exception that the gas should be applied to the ESH-A sensor opening instead of the DCC sensor opening.**

## 9 ACCESSORIES

### 9.1 Splash Guard (Option: -S)



The splash guard attaches to the front of the enclosure to protect the sensor during water spray of washdown applications. It is factory installed and when attached the enclosure meets IP54 standards.

**NOTE:** The splash guard will slow down the response time of the sensor.

### 9.2 Calibration Adapter Clip “Cal Clip” (p/n: CET-SGC)

Attach the Cal Clip around the splash guard to allow the use of both hands during calibration. The small barb hose fitting accommodates standard or Teflon tubing of 1/8” (3.175 mm) ID and 3/16” (4.762 mm) ID.

**NOTE:** The Cal Clip is designed to prevent entry or exit of air except via the hose barb fitting, therefore it must be removed from the splash guard during normal operation or else the gas readings will not be accurate.



### 9.3 Top Mounted Strobe (Option: -L)

High powered, red LED flashing beacon factory installed on the top of the DCC enclosure. Offers excellent

flash intensity, durable vibration resistant construction and a long life 100,000 hour LED technology. Made of tough Lexan spun welded to the base to completely seal out moisture. NEMA 4X and UL recognized. Ideal for refrigeration applications; when combined with the Manual Shutoff Switch, meets B52 code requirements.



Voltage	12 - 80 VDC
Amperage	200 mA @ 24 VDC
Size	114 mm (4.5 in) H x 76 mm (3 in) dia
Lens Colour	Red (other colours may be available upon request)
# of Flashes	75 Neobe <sup>®</sup> flashes per minute
Flash Pattern	each flash consists of 7 rapid bursts of light
Operating Temperature	-40°C to 65°C (-40°F to 149°F)

#### 9.4 Metal Protective Guard (p/n: SCS-8000-SPG)

The metal protective guard is made of heavy gauge, galvanized metal and helps to protect against abrasive damage, theft or vandalism to the transmitter. The 16-gauge galvanized steel has ½" (13 mm) square openings in the front to allow gas and air to flow through to the sensor. With only four slotted mounting holes, installation and removal for gas detector servicing is easy.

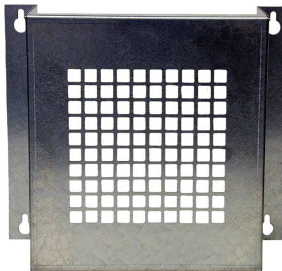

Enclosure	16 gauge galvanized steel
Weight	1.7 kg (3.8 lbs)
Size	10.0" W x 9.5" H x 4.8" D (254 mm W x 241 mm H x 121 mm D)

### 9.5 Magnetic Wand (p/n: CET-MW)

The magnetic wand is used for non-intrusive calibration, using the magnetic sensors on the front of the enclosure next to the sensor vent.



Lifts	½ lb solid steel
Size	2 5/8" X 1/4" Hexagon

### 9.6 Calibration Kit (p/n: CET-715A-CK1)

The Calibration Kit contains the items necessary for common field and shop calibration of all gas detection models (new and old) manufactured by CETCI. It comes in a durable, hard plastic carrying case. **Gas cylinders are not included in the Kit.** They must be ordered separately from the CETCI factory. Many gases are carried in inventory but not all. Check with any CETCI authorized distributor for availability of specific gas types. **Gas cylinders cannot be shipped from Canada to other countries, including the USA.** For more information check out our website <http://www.critical-environment.com/products/calibration-kit.html>



## 10 MAINTENANCE

The DCC requires no assembly and virtually no maintenance other than regular calibration of the integral and/or remote sensors. It is important to ensure that excess water and/or dust is not somehow entering the enclosure and physically damaging the circuit board or internal components. There are no serviceable elements other than the calibration instructions outlined in this manual. There are no replaceable components except the sensors.



The self-contained controller should be monitored for possible damaging conditions.

- The sensor vent should be kept free of dirt or soot build up.
- If in a damp location, source of water should be shielded from contacting the top of the controller.
- If located in a working area, the front of the self-contained controller should be kept clear.
- If painting is to be conducted in the self-contained controller's location the controller needs to be protected from over spray and the sensor vent should not receive paint fumes – these fumes may damage and/or reduce the life of the sensor.

## 11 TROUBLE SHOOTING

### **DCC won't power up. (Outer LEDs off and/or display off)**

Is the power properly connected? Check the connections. Refer to Section 6.7 *Wiring Power Connections*.

### **The channel LED flashes red and the fault LED is ON**

The DCC is in fault mode for the indicated channel. If re-calibrating the sensor fails it will need to be replaced. Depending on the sensor this can be done in the field or require a return to factory.

### **DCC is constantly in alarm condition (Channel LED shows amber or red)**

Sensor may be out of calibration, attempt to recalibrate. If calibration fails, contact support.

### **DCC Channel connected to remote 4-20mA transmitter constantly in alarm condition (Channel LED shows red)**

The analog output jumpers may not be set properly. Make sure JP1 jumper is set to 24V and the JP2 jumper is set to CURRENT, otherwise it won't work.

### **Remote transmitter will not power up even though DCC is powered.**

Check for short between V+, SNS and GND lines from DCC to remote transmitter. Make sure JP1 jumper is set to 24V.







Distributed by:

Kenelec Scientific Pty Ltd  
1300 73 22 33  
sales@kenelec.com.au  
www.kenelec.com.au

**Critical Environment Technologies Canada Inc.**

Unit 145, 7391 Vantage Way, Delta, BC, V4G 1M3, Canada

Toll Free: +1.877.940.8741

Tel: +1.604.940.8741

Fax: +1.604.940.8745

[www.critical-environment.com](http://www.critical-environment.com)

